

MITEL

5320/5330/5340

IP Phone User Guide

















# 5320/5330/5340 IP Phone Quick Reference Guide

This guide provides information for frequently used features. For more information about these and other features, refer to the user guide. For voice mail information, refer to the voice mail user guide for your system.

## Feature Buttons

Most of the following feature codes work when your phone is idle. However, if you are on an active call or if the phone is off-hook, you may need to press  (Special) to activate the feature before you enter the feature code.

If you make a mistake when entering numbers or characters, you can press  (Hold) to move the cursor to the left and delete the characters entered, or you can press \* to cancel the feature.

Button	Action
 (Up)	Provides volume control.
 (Down)	Scrolls through feature options.
 (Speaker)	Activates Handsfree Mode. Activates features.
 (Mute)	Mutes the microphone during a call.
 (Applications)	Activates the Application menu to view system information and adjust Contrast and Brightness settings.
 (Special)	Activates features while on a call. The  (Special) button does not cancel features. To cancel features, press the Star button (*).
 (Redial)	Calls the last external number dialed. You cannot redial internal numbers.
 (Hold)	Places the current call on hold. Left/Backspace when entering dialpad characters.
 (Transfer)	Transfers the current call. Right/Forward when entering dialpad characters.
 (Message)	Connects to voice mailbox and notifies when you have messages. Toggles between Alpha Mode and Numeric Mode.

## Commonly Used Feature Codes

Contact your system administrator for more information about system features.

Feature	Code
ACD Agent – Log In/Out	328
Automatic IC Call Access – On/Off	361
Automatic Trunk Call Access – On/Off	360
Background Music – On/Off	313
Call Forward – All Calls	355
Call Logging	333
Conference	5
Default Station	394
Directory	307
Display Time And Date	300
Do-Not-Disturb – On/Off	372
Handsfree – On/Off	319
Headset – On/Off	317
Hold – Individual	336
Hold – System	335
Hunt Group – Remove/Replace	324
Message – Cancel Left Message	366
Message – Delete Message	368
Message – Leave Message	367
Message – View Messages Menu	365
Microphone Mute – On/Off	314
Page Receive – On/Off	325
Personal Call Routing – On/Off	364
Personal Call Routing Handoff	388
Program Buttons	397
Program Station Password	392
Programmable Buttons – Default	395
Queue (Callback) Request	6
Record-A-Call	385
Reverse Transfer (Call Pick-Up)	4
Ring Tone Selection	398
Station Speed Dial	382
Station Speed Dial – Programming	383
Switch Keymap	399
System Forward – On/Off	354
System Speed Dial	381
View Button Assignments	396

---

## Answering Calls

Lift the handset, or press  (Speaker) to answer a call while using a headset or to answer a call in Handsfree Mode.

## Placing Emergency Calls

Dial the emergency number (911 U.S. or 999/112 Europe). The system immediately places the emergency call as soon as you dial the number, even if you do not select an outside line.

## Placing Internal (Intercom) Calls

With or without the handset lifted, dial the extension number. If you enter incorrect digits, you can press  (Hold) to move the cursor backward, deleting the last digits entered. If you are using Handsfree Mode, listen for the double tone, and then begin to speak.

## Placing External Calls

Press the **Outgoing** button, an unlit **Call** button, or enter the Outgoing Call access code (**8** is the default code), and then dial the number.

## Redialing External Numbers

With or without the handset lifted, press the  (Redial). The system automatically selects a line and dials the number.

## Transferring Calls to Other Extensions

1. While on the call, press  (Transfer), and then enter the extension number.
2. Do one of the following:
  - Wait for an answer, announce the call, and then hang up. If the extension is unavailable, press the flashing **IC** or **Call** button to return to the caller.
  - Hang up to transfer the call and disconnect the call from your phone.



## Forwarding Calls

1. Press the **Fwd** button, and then enter the feature code, if applicable. ENTER FORWARD DEST appears.
2. Enter the extension number, or press the **Outgoing** button or enter the Outgoing Call access code (**8** is the default code), and then dial the telephone number.



## Placing Conference Calls

1. While on the first call, press the **Conf** button to place the call on hold. CALL NEXT PARTY TO CNF appears.
2. Place a call to the next conference party. For external calls, press the **Outgoing** button or enter the Outgoing Call access code (**8** is the default code), and then dial the number.
3. After the party answers, announce the conference, and then press the **Conf** button to place the call on hold. If necessary, repeat this step to add the remaining conference party.
4. Press the **Conf** button again to start the conference. CNF IN PROGRESS appears.

## Viewing and Responding to Messages

1. With the handset on-hook, press  (Message) or the **VIEW MESSAGE** menu button (5340 IP Phones only). Messages are displayed as first in/first out. If there is more than one message, you can repeatedly press  (Message) to scroll through the messages.
2. When the desired message is displayed, press **#**, or lift the handset for privacy, and then press **#** to respond. (If your handset is off-hook and you press  [Message], you automatically place a call to the party or message center who left the message.)

## Using Do-Not-Disturb

1. Press the **DND** button, and then do one of the following:
  - Press  (Up) or  (Down) to scroll through the messages.
  - Enter the two-digit number for the DND message.
2. If applicable, enter the additional text for the DND description.
3. Press  (Speaker), or lift and replace the handset.

## Placing a Page Announcement

1. Press **7**.
2. Enter the page-zone number (**0** to **9**).
3. After the tone, make your announcement, and then hang up.

---

## Notice

This guide is released by Mitel Networks Corporation and provides information necessary to use the 5320/5330/5340 IP Phones. The guide contents, which reflect current Mitel standards, are subject to revision or change without notice.

Some features or applications mentioned may require a future release and are not available in the initial release. Future product features and applications are subject to availability and cost. Some features or applications may require additional hardware, software, or system administrator assistance.

**For sales, service, or technical support, contact your local authorized provider:**

---

Enter provider information above.

If you do not know the contact information for your local provider, use the “Partners” link at the top of the [Mitel home page](#) ([www.mitel.com](http://www.mitel.com)) to find a location near you.

If you have any questions or comments regarding this user guide or other technical documentation, contact the Technical Publications Department (USA) at:

[tech\\_pubs@mitel.com](mailto:tech_pubs@mitel.com)

Mitel® is a registered trademark of Mitel Networks Corporation.

All other trademarks mentioned in this document are the property of their respective owners, including Mitel Networks Corporation. All rights reserved.

© 2008-2009 Mitel Networks Corporation

Personal use of this material is permitted. However, permission to reprint/republish this material for advertising or promotional purposes or for creating new collective works for resale or redistribution to servers or lists, or to reuse any copyrighted component of this work in other works must be obtained from Mitel.

---

## Important Safety Instructions and Precautions

Remember the following safety guidelines when using the phone.





### Programming Emergency Numbers

Make sure to do the following when programming emergency numbers and/or making test calls to emergency numbers:

- Remain on the line and briefly explain to the dispatcher the reason for the call.
- Perform tests during off-peak hours such as early morning or late evenings.

### Safety Notices

The following notices may appear on the product or in the technical documentation.

Notice	Description
 <b>CAUTION</b>	Caution indicates a potentially hazardous situation which, if not avoided, may result in minor or moderate injury and/or damage to the equipment or property.
 <b>WARNING</b>	Warning indicates a potentially hazardous situation which, if not avoided, could result in death or serious injury.
 <b>DANGER</b>	Danger indicates an imminently hazardous situation which, if not avoided, will result in death or serious injury.
	The exclamation point within an equilateral triangle indicates that important operating and maintenance (servicing) instructions are included in the literature accompanying the product.

### Maintenance and Repair

There are no user serviceable parts inside the phones. For repairs, return the phone to an authorized Mitel provider.

---

**NOTE**

Changes or modifications not expressly approved by Mitel may void the user's right to operate the equipment.

---

## Power Requirements

### CAUTION

**Phone Damage Hazard.** To avoid damaging the phone, make sure the phone is connected to the proper power supply before powering on. Contact your system administrator for more information.

The phone requires *any* one of the following power supplies:

- Mitel 48-volt DC Ethernet power adaptor 100-240 volt AC 50-60Hz (ES) -part number 50005301
- An industry-standard IEEE 802.3af Power over Ethernet (PoE) power supply unit

If your phone uses a centralized PoE power supply unit, do **not** use the 48-volt DC Ethernet power adaptor. If necessary, contact your system administrator for assistance before connecting your phone to the centralized power source.

Make sure the phone is plugged into an uninterruptible power supply (UPS). If your phone is plugged into the UPS and the power fails, it should remain powered on for about 10 minutes. If the phone is not plugged into a UPS and the power fails, the current call is dropped and you will not be able to use the phone until the power is restored.

## Software Updates

### CAUTION

**Phone Damage Hazard.** Do not use your phone or disconnect it from the power supply while it is updating software.

The phone may require occasional software updates when new versions are available. The phone is configured to download the updates automatically. Contact your system administrator for more information.

## Product Disposal Instructions



This symbol indicates that the product is classified as electrical or electronic equipment and should not be disposed of with other commercial or household waste at the end of its working life. For appropriate disposal and recycling instructions, contact your local Mitel provider.

*The Waste of Electrical and Electronic Equipment (WEEE) Directive (2002/96/EC) was established by the European Union to minimize negative impact on the environment, control hazardous substances, and curtail landfill expansion by using the best available recovery and recycling techniques.*

---

## Phone Usage

This equipment is not for connection to the telephone network or public coin phone service. It is only for use when connected to Mitel systems.

### **WARNING**

When using your phone equipment, basic safety precautions should always be followed to reduce the risk of fire, electric shock and injury to persons, including the following:

- Do not use this product near water, for example, near a bath tub, wash bowl, kitchen sink or laundry tub, in a wet basement, or near a swimming pool.
- Avoid using a phone (other than a cordless type) during an electrical storm. There may be a remote risk of electric shock from lightning.
- Do not use the phone to report a gas leak in the vicinity of a leak.
- Do not connect directly to the Public Switched Telephone Network (PSTN). Any connection of this phone to an off premise application, an out of plant application, any other exposed plant application, or to any equipment other than the intended application may result in a safety hazard, and/or defective operation, and/or equipment damage. "Exposed plant" means where any portion of the circuit is subject to accidental contact with electric lighting or power conductors operating at a voltage exceeding 300 volts between conductors or is subject to lightning strikes.
- The socket outlet, if used, shall be located near the equipment and shall be easily located by the user.
- Use only Mitel approved power adaptors. See "Power Requirements" on [page iii](#).
- The handset supplied with the phone is not certified for use with any other phone. Use of the handset with any other phone may have the potential to cause hearing loss in the event of a lightning strike on the outside plant wiring.



---

## Notice to Canadian Customers

The Class B digital apparatus complies with Canadian ICES-003.

## Notice to U.S. Customers

This equipment has been tested and found to comply with the limits for a Class B digital device, pursuant to Part 15 of the FCC Rules. These limits are designed to provide reasonable protection against harmful interference in a residential installation. This equipment generates, uses, and can radiate radio frequency energy and, if not installed and used in accordance with the instructions, may cause harmful interference to radio communications. However, there is no guarantee that interference will not occur in a particular installation. If this equipment does cause harmful interference to radio or television reception, which can be determined by turning the equipment off and on, the user is encouraged to try to correct the interference by one or more of the following measures:

- Reorient or relocate the receiving antenna.
- Increase the separation between the equipment and receiver.
- Connect the equipment into an outlet on a circuit different from that to which the receiver is connected.
- Consult the dealer or an experienced radio/TV technician for help.

## Notice to European Customers



We, Mitel Networks LTD.  
Of, Mitel Castlegate Business Park  
Portskewett  
Caldicot  
NP26 5YR  
UK

Declare that for the hereinafter mentioned product the presumption of conformity with the applicable essential requirements of DIRECTIVE 1999/5/EC OF THE EUROPEAN PARLIAMENT (RTTE DIRECTIVE) AND OF THE COUNCIL is given.

Mitel Phones: 5320/5330/5340

Any unauthorized modification of the product voids this Declaration.

For a copy of the original signed Declaration of Conformity (in full conformance with EN45014), please contact the Regulatory Approvals Manager at the above address.



# Contents

<b>Getting Started</b>	<b>1</b>
<b>Welcome</b>	<b>1</b>
<b>About Your Phone</b>	<b>1</b>
5320/5330 IP Phone Features	2
5340 IP Phone Features	3
Phone Feature Descriptions	3
Handset	3
Display	4
Ring/Message Indicator	4
Speaker	4
Feature Buttons	5
Dialpad Buttons	5
Programmable Buttons	6
Menu Buttons (5340 IP Phones only)	6
Navigation Page Buttons	6
<b>Phone Signals</b>	<b>7</b>
<b>Comfort and Safety Tips</b>	<b>7</b>
<b>Headset Instructions</b>	<b>8</b>
<b>System Information</b>	<b>8</b>
<b>Personalizing Your Phone</b>	<b>9</b>
<b>Adjusting the Viewing Angle</b>	<b>9</b>
<b>Changing Volume Levels</b>	<b>10</b>
<b>Changing the Ring Tone</b>	<b>10</b>
<b>Adjusting the Display Contrast and Brightness</b>	<b>10</b>
<b>Using the Screen Saver</b>	<b>11</b>
<b>Changing the Text Size on a Display</b>	<b>14</b>
<b>Changing the Language</b>	<b>14</b>
<b>Listening to Background Music</b>	<b>15</b>
<b>Using Programmable Buttons</b>	<b>15</b>
Additional Programmable Buttons	15
Default Access Codes	16
Outside Line Access Codes	16
Extension Numbers	16
Default Feature Codes	16
<b>Viewing Button Assignments</b>	<b>19</b>
<b>Resetting Programmable Buttons</b>	<b>19</b>

---

Resetting the Phone to the Default Settings . . . . .	19
Switching Keymaps . . . . .	19
<b>Answering and Placing Calls</b>	<b>21</b>
<hr/>	
<b>Answering Calls</b> . . . . .	<b>21</b>
Answering Waiting Calls . . . . .	21
Using Automatic Call Access . . . . .	21
Redirecting Calls . . . . .	22
<b>Using Automatic Trunk Answer</b> . . . . .	<b>22</b>
<b>Placing Calls</b> . . . . .	<b>22</b>
Placing Emergency Calls . . . . .	22
Placing Internal Calls . . . . .	23
Requesting a Callback (Queuing the Phone) . . . . .	23
Using Camp-on . . . . .	23
Placing External Calls . . . . .	24
Redialing a Number . . . . .	24
<b>Using Speed Dial</b> . . . . .	<b>24</b>
Using System Speed Dial . . . . .	24
Using Station Speed Dial . . . . .	25
Storing Station Speed-Dial Numbers . . . . .	25
Using the Dialpad Buttons to Enter Characters . . . . .	25
Dialing Station Speed-Dial Numbers . . . . .	26
Deleting Speed-Dial Entries . . . . .	27
Assigning Speed-Dial Entries to Programmable Buttons . . . . .	27
<b>Using the Directory</b> . . . . .	<b>28</b>
<b>Using Account Codes</b> . . . . .	<b>29</b>
<b>Call Features</b>	<b>31</b>
<hr/>	
<b>Using Handsfree Mode</b> . . . . .	<b>31</b>
<b>Using Ring Intercom Always</b> . . . . .	<b>31</b>
<b>Using Mute</b> . . . . .	<b>31</b>
<b>Placing Calls On Hold</b> . . . . .	<b>32</b>
<b>Entering a Hookflash</b> . . . . .	<b>32</b>
<b>Transferring Calls</b> . . . . .	<b>32</b>
Transferring Calls to Other Extensions . . . . .	32
Transferring Calls to External Numbers . . . . .	33
Using Reverse Transfer . . . . .	33
<b>Viewing Your System Information</b> . . . . .	<b>33</b>
<b>Viewing Caller ID Information</b> . . . . .	<b>33</b>

---

<b>Forwarding Calls</b> .....	<b>34</b>
Manual Call Forwarding .....	34
System Forwarding .....	34
<b>Using Personal Call Routing</b> .....	<b>35</b>
<b>Placing Conference Calls</b> .....	<b>37</b>
Adding a Conference Party .....	37
Transferring a Conference .....	37
Dropping Out of a Conference .....	37
Ending a Conference and Placing all Parties on Hold .....	38
<b>Using Record-A-Call</b> .....	<b>38</b>
<b>Using Group Listen</b> .....	<b>38</b>
<b>Using Call Logging</b> .....	<b>39</b>
<b>Using Secondary Extension Buttons</b> .....	<b>40</b>
<b>Remote Programming</b> .....	<b>40</b>
Entering a Remote Programming Password .....	40
Using Remote Programming to Change the Password .....	41
Using Remote Programming to Change DND Settings .....	41
Using Remote Programming to Forward Calls .....	42
Using Remote Programming for Personal Call Routing .....	42
<b>Messages</b> .....	<b>43</b>
<b>Leaving Messages at Other Extensions</b> .....	<b>43</b>
<b>Viewing and Responding to Messages</b> .....	<b>44</b>
Canceling Messages Left at Other Extensions .....	44
Deleting Waiting Inter-Station Messages .....	44
<b>Using Do-Not-Disturb (DND)</b> .....	<b>45</b>
<b>Using Reminder Messages</b> .....	<b>46</b>
<b>Paging Other System Users</b> .....	<b>47</b>
Placing a Page Announcement .....	47
Enabling or Disabling the Paging Feature .....	47
<b>Hunt Groups</b> .....	<b>49</b>
<b>Logging in to ACD Hunt Groups</b> .....	<b>49</b>
<b>Logging out of ACD Hunt Groups</b> .....	<b>50</b>
<b>Stopping the ACD Hunt Group Wrap-up Timer</b> .....	<b>50</b>
<b>Other Hunt Group Features</b> .....	<b>50</b>
Requesting Agent Help .....	50
Diverting Hunt Group Calls .....	51

## Contents

---

<b>Hunt Group Supervisor Features</b> .....	<b>51</b>
Accepting or Rejecting Agent Help Calls .....	51
Monitoring Calls .....	52
Using Barge-in .....	52
Stealing Hunt Group Calls .....	52
<b>Cordless Devices (5330/5340 IP Phones Only)</b> .....	<b>53</b>
<b>Cordless Module</b> .....	<b>54</b>
<b>Handset and Headset Combinations</b> .....	<b>54</b>
<b>Pairing the Cordless Module and Devices</b> .....	<b>55</b>
<b>Using a Cordless Device as a Remote Control</b> .....	<b>56</b>
<b>Alerting Tones and LEDs</b> .....	<b>56</b>
<b>Low Battery Level</b> .....	<b>56</b>
<b>Cordless Handset</b> .....	<b>57</b>
Cordless Handset Features .....	57
Answering Calls .....	58
Hanging Up .....	58
Cordless Handset LEDs .....	58
<b>Cordless Headset</b> .....	<b>59</b>
Cordless Headset Features .....	59
Answering Calls .....	59
Hanging Up .....	59
Cordless Headset LEDs .....	60
Using the Cordless Devices Application .....	60
<b>Troubleshooting</b> .....	<b>61</b>
<b>Contact Information</b> .....	<b>61</b>
<b>Error Messages</b> .....	<b>61</b>
<b>Troubleshooting Tips</b> .....	<b>62</b>
<b>Index</b> .....	<b>65</b>

---

---

# Getting Started

## Welcome

The instructions in this guide are for using the Mitel Model 5320/5330/5340 Internet Protocol (IP) Phone on the Mitel 5000 Communications Platform (CP). The *Quick Reference Guide* is an overview of frequently used features.

Your phone should be powered on and ready to use. If the display is blank, or if the display name, extension number, or time or date are incorrect, contact your system administrator for assistance.

Because a variety of voice mail products work with the 5000 CP, this guide does not include voice mail instructions. For voice mail instructions, refer to the voice mail user guide for your system. For example, refer to the *Enterprise Messaging, Basic Voice Mail, and Embedded Voice Mail Card User Guide*, part number 835.3205, or the *Mitel NuPoint Unified Messaging User Guide* on the [Mitel Web site](http://edocs.mitel.com) (<http://edocs.mitel.com>). Contact your system administrator for more information about your voice mail system.

---

**NOTE**

Because many phone features can be programmed to perform various tasks, some features may work differently than the descriptions in this guide. Contact your system administrator for more information.

## About Your Phone

The IP Phones are full-feature, dual port phones that provide voice communication over an IP network. All phones have a 160 x 320 (pixels) liquid crystal display (LED), self-labeling programmable buttons, on-hook dialing, and a Ring/Message Indicator.

For one-touch feature access, the 5320 IP Phone has 8 programmable buttons, the 5330 IP Phone has 33 programmable buttons, and the 5340 IP Phone has 42 programmable buttons.

## 5320/5330 IP Phone Features

The 5320 and 5330 IP Phones are shown here.<sup>1</sup> See “Phone Feature Descriptions” on [page 3](#) for more information about the phone features.

### 5320 IP Phone



### 5330 IP Phone



- |                                       |                             |
|---------------------------------------|-----------------------------|
| 1 – Handset                           | 5 – Feature buttons         |
| 2 – Programmable buttons <sup>1</sup> | 6 – Dialpad buttons         |
| 3 – Display <sup>2</sup>              | 7 – Navigation page buttons |
| 4 – Ring/Message Indicator            | 8 – External speaker        |

1. The top three buttons on the 5320 IP Phone do not have LEDs.
2. The 5320 IP Phone does not have a backlit display.

1. These images are examples of how your phone may be programmed.



## 5340 IP Phone Features

The 5340 IP Phone is shown here.<sup>2</sup> See “[Phone Feature Descriptions](#)” below for more information about the phone features.



- |                            |                             |
|----------------------------|-----------------------------|
| 1 – Handset                | 6 – Dialpad buttons         |
| 2 – Display                | 7 – Programmable buttons    |
| 3 – Menu buttons           | 8 – Navigation page buttons |
| 4 – Message Indicator lamp | 9 – External speaker        |
| 5 – Feature buttons        |                             |

## Phone Feature Descriptions

The following sections describe default configurations. Your phone may be programmed differently. Contact your system administrator for more information. See “[5320/5330 IP Phone Features](#)” on [page 2](#)” and “[5340 IP Phone Features](#)” above for phone feature locations.

### Handset

The handset provided with this equipment is hearing aid compatible (HAC). If you are using a headset or if you are in Handsfree Mode, you do not need to use the handset. See “[Headset Instructions](#)” on [page 8](#) and “[Using Handsfree Mode](#)” on [page 31](#) for more information.

<sup>2</sup> This image is an example of how your phone may be programmed.

### Display

The display provides a 160 x 320 (pixels) high-resolution viewing area for selecting and using features and identifying callers. When idle, the display shows user information, the system time and date, and feature button assignments. Consider the following when using the display:

- The 5320 IP Phone does not have a backlit display.
- You can adjust the display Contrast and Brightness levels (see [page 10](#)).
- 5330 and 5340 IP Phones include an embedded screen saver that you can configure for your display. Configuration options include the screen saver timeout, display image, and brightness options (see [page 11](#)).
- You can control the size of the text that appears on the display for programmable buttons (see [page 14](#)).

### Ring/Message Indicator

The Ring/Message Indicator flashes or stays lit to indicate call, message, and feature activity. For more information about messaging features, see “Messages” on [page 43](#). Ring/Message Indicator signals are described in the following table.











Indicator Signals	Description
Rapidly flashing	You have an incoming call.
Slowly flashing	You have a waiting message or callback message.
On	You are on a call or using a feature.
Off	Your phone is idle.

### Speaker

The speaker provides audio for handsfree calls and background music. See “Using Handsfree Mode” on [page 31](#) for information about handsfree calls. See “Listening to Background Music” on [page 15](#) for more information about background music.

## Feature Buttons

Feature buttons provide quick access to commonly used features. See the following table for descriptions.

Button	Action
 (Up) or  (Down)	Provides volume control for the ringer, handset, and speaker. Scrolls through feature options.
 (Speaker)	Activates Handsfree Mode (speakerphone). See “Using Handsfree Mode” on <a href="#">page 31</a> . Activates features.
 (Mute)	Temporarily turns off your microphone during a call.
 (Applications)	Activates the Application menu to view system information and adjust Contrast and Brightness settings. See “Dial 317 (Headset on/off). HEADSET MODE OFF appears.” on <a href="#">page 8</a> and “Adjusting the Display Contrast and Brightness” on <a href="#">page 10</a> .
 (Special)	Activates features while on a call. The  (Special) button does not cancel features. To cancel features, press the Star button (*).
 (Redial)	Calls the last <i>external</i> number dialed. You cannot redial internal numbers.
 (Hold)	Places the current call on hold. Left/backspace when entering dialpad characters. See “Using the Dialpad Buttons to Enter Characters” on <a href="#">page 25</a> .
 (Transfer)	Transfers the current call. Right/forward when entering dialpad characters. See “Using the Dialpad Buttons to Enter Characters” on <a href="#">page 25</a> .
 (Message)	Connects to your voice mailbox and flashes to notify you of waiting messages. Toggles between Alpha Mode and Numeric Mode when entering dialpad characters.

## Dialpad Buttons

Use the dialpad buttons to dial phone numbers, enter feature codes, and to enter characters when using features that require text input.

### Programmable Buttons

The IP Phones have self-labeling, programmable buttons. The 5320 IP Phone has 11 programmable buttons. The 5330 IP Phone has 33 programmable buttons. The 5340 IP Phone has 42 programmable buttons. Each phone has the following buttons that are programmed by the system administrator and cannot be reprogrammed; however, you can program the remaining buttons for quick access to features or speed-dial entries. See “Using Programmable Buttons” on [page 15](#).

Button	Action
Do-Not-Disturb	Turns Do-Not-Disturb (DND) mode on or off.
Outgoing	Selects an outgoing line for external calls.
Call 1	Selects an outside line or answers a call.
Call 2	Selects an outside line or answers a call.
Intercom	Answers an intercom (internal) call.
Conference	Places a conference call.
Forward	Forwards the call to the specified number.

### Menu Buttons (5340 IP Phones only)

The 5340 IP Phone has eight dynamic menu buttons at the top of the Display that change depending on the feature and menu currently displayed. You can use the menu buttons to view and select feature options.

### Navigation Page Buttons

The IP Phones have three Navigation Page icons located in the bottom right hand corner of the display to navigate between the phone's three display pages. When a page icon in the bottom right-hand corner of the Display blinks, it means that there is real-time activity on the page where the number or feature is located.

If you navigate to the second or third pages, you must use the Navigation Page buttons to return to the first page. You are not automatically returned to the first page after using features or when the phone is idle. You can also press the  (Home) button on the 5340 IP Phone (only) to return to the first page.

---

## Phone Signals

The IP Phones have several audio and visual signals to indicate feature activity. The following are a few helpful tips:



- Lit or blinking buttons indicate call or feature activity.
- All phone button lamps illuminate at the same time for a few seconds when the phone is reset or powered on.
- The following actions may cause an error tone:
  - Pressing an invalid button combination.
  - Selecting a restricted feature.
  - Dialing a restricted or invalid number.
  - Dialing too slowly between digits.
  - Waiting too long before performing the next step.To correct an error tone, hang up and try again.
- Many features “time-out” if you wait too long before performing the next step. If this happens, you must start over.
- “Off-hook” means the handset is lifted. “On-hook” means the handset is in the cradle.
- If your phone does not have a lamp under the speaker button, the large message indicator lamp on the top right of the phone indicates that the speakerphone is in use.

## Comfort and Safety Tips

Observe the following comfort and safety tips when using the phone:

- **Do not cradle the handset:** Prolonged use of the handset can lead to neck, shoulder, or back discomfort, especially if you cradle the handset between your neck and shoulder. If you frequently use the phone, you might find a headset more comfortable. See [“Headset Instructions”](#) below.
- **Adjust the viewing angle:** The built-in stand tilts to give you a better view of the buttons. See “Adjusting the Viewing Angle” on [page 9](#).
- **Protect your hearing:** Because prolonged exposure to loud sounds can contribute to hearing loss, keep the volume at a moderate level. You can adjust the volume levels of the handset receiver or headset. See “Changing Volume Levels” on [page 10](#).

## Headset Instructions

When using a headset, press  (Speaker) to connect to or disconnect from calls. The Headset icon  appears when the headset is in use. You cannot use the handset or speakerphone when the phone is in Headset Mode. Disconnecting the headset automatically enables the handset.

### NOTES

The headset must be hearing aid compatible (HAC).

If your headset has a power-saver mode, make sure the system administrator has enabled the “Headset Connect Tone” feature. If this is not enabled, you may miss the first few seconds of an incoming call.

### To connect and activate the headset:

1. Insert the headset jack into the Headset port  located on the back of the phone.
2. Dial **317** (Headset on/off). HEADSET MODE ON appears.

### NOTE

Because Headset Mode disables the handset and speakerphone, you must turn off Headset Mode before you can use the handset or speakerphone.

### To turn off Headset Mode and activate the handset and speakerphone:

Dial 317 (Headset on/off). HEADSET MODE OFF appears.

## System Information

You can use the phone to view system or phone information.

### To view system information:

1. Press  (Applications).
2. Press **About 5320/5330/5340 IP Phone**. A screen similar to the following appears.

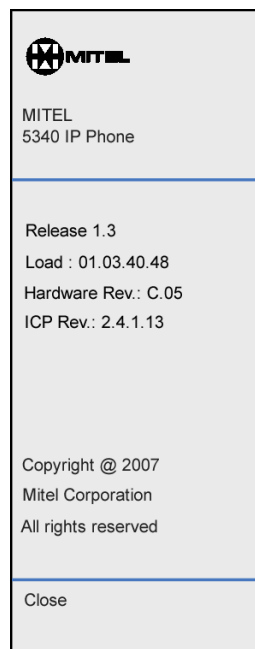

3. Press **Close** to exit the Applications menu.

# Personalizing Your Phone

This chapter describes features you can use to personalize your phone.

## Adjusting the Viewing Angle

You can tilt the phone stand for a better view of the buttons and display.

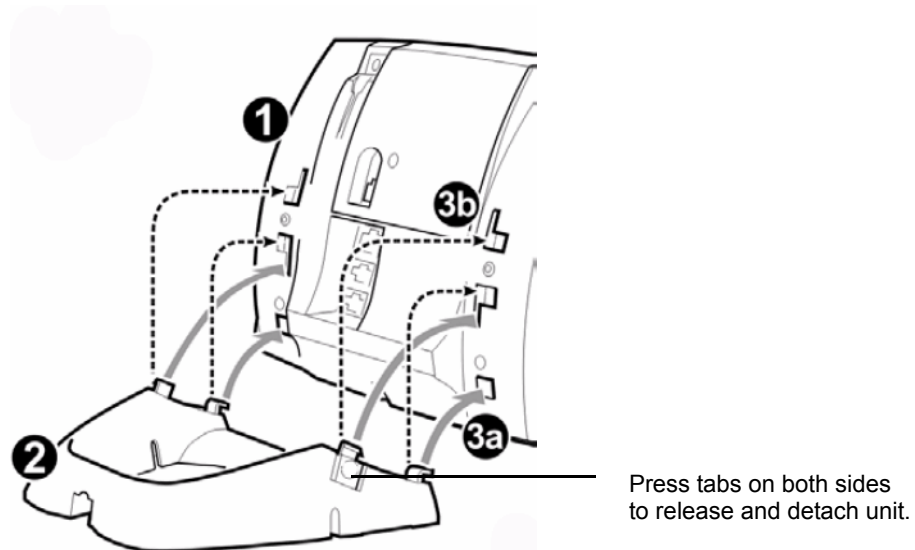

### To adjust the viewing angle:

1. Turn the phone so it faces away from you.
2. Hold the base firmly, and then press the tabs on the sides of the stand to release and detach the base unit.
3. Hinge the hooks on the base unit into the notches on the back of the phone, and then snap into place as follows:
  - For a *high-angle mount*, hinge the two lower hooks into the bottom set of notches, and then snap the two upper hooks into the middle set of notches.
  - For a *low-angle mount*, hinge the two lower hooks into the middle set of notches, and then snap the two upper hooks into the top set of notches.

## Changing Volume Levels

You can change the following volume levels:

- Ringer (alerting tone)
- Handset
- Headset
- Background music
- External speaker

### NOTE

Turning the external speaker volume down to the lowest levels may prevent you from hearing the feature “warning tones” that notify you when errors occur (for example, when you enter an incorrect feature code).

You must be using the feature to change the volume level. For example, if you want to change handset volume level, you must be using the handset. However, you can adjust the ringer (alerting tone) volume level when the phone is idle.

### To change a volume level:

While using the feature, press ▲ (Up) to increase the volume or press ▼ (Down) to decrease the volume. The volume level is automatically saved.

## Changing the Ring Tone

You can select one of nine different ring tones.

### To change the ring tone:

1. With the handset on-hook, dial **398**.
2. Do one of the following to listen to (or turn off) ring tones:
  - Press **0** or the **RINGER OFF** menu button (5340 IP Phones only) to turn the ringer off.
  - Press (Up) or (Down) or **1** to **9** to listen to ring tones.
  - Press the **PREVIOUS** or **NEXT** menu buttons (5340 IP Phones only) to listen to and select a ring tone.
3. Press **Ⓜ** (Speaker), **#**, the **ACCEPT** menu button (5340 IP Phones only), or lift and replace the handset to select the ring tone.

## Adjusting the Display Contrast and Brightness

You can adjust the display Contrast and Brightness levels.

### NOTE

By default, the phone display dims to 20 percent of the maximum brightness level after 5 minutes of inactivity (no button presses or audio, including background music). If the brightness is set at the lowest level, you may not notice when the display dims.

### To adjust the Contrast or Brightness levels:

1. Press **Ⓜ** (Applications).
2. Press **Brightness and Contrast**.
3. Press (**Contrast** or **Brightness**) **+** or **-** to find the desired level.
4. Press **#** or **Save** to save the setting, and then press **Close** to exit the Applications menu.





## Using the Screen Saver

The 5320, 5330, and 5340 IP Phones include an embedded screen saver that you can configure for your display.

By default the screen saver image is disabled. When your phone enters screen saver mode, only the phone's backlight dims. All 5340 and newer 5330 IP Phones have a backlit display. 5320 IP Phones do not have a backlit display.

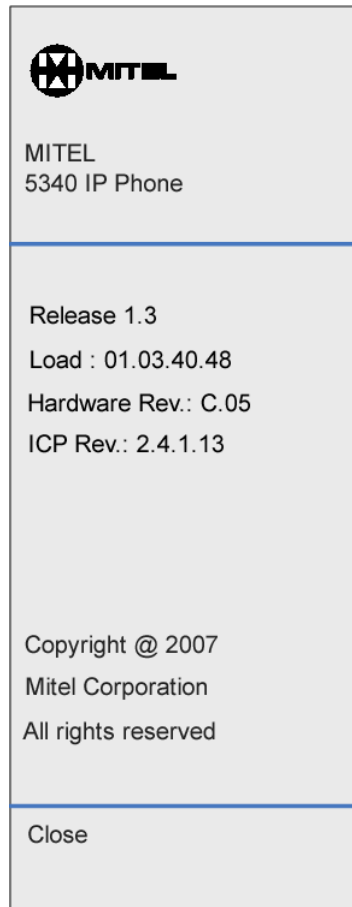
You can enable the screen saver image and when your phone enters screen saver mode, the phone's backlight dims and the embedded screen saver image, similar to the one below, appears on your display.

**NOTE**

The screen saver image is the same image you see when you press  (Applications) and select the **About 5330/5340 IP Phone** menu option.

Screen saver options include the following:

- **Screen saver timeout:** Specifies how long your phone is idle before it enters screen saver mode. Options include 1 minute, 5 minutes, 10 minutes, and 15 minutes. By default, the timeout period is set to 5 minutes.
  - **Display Image option:** Specifies how your phone's screen saver mode functions:
    - *If you enable the screen saver image*, the image appears and your backlight dims when your phone enters screen saver mode.
    - *If you disable the screen saver image*, only your backlight dims when your phone enters screen saver mode.
- By default, the **Display Image** option is disabled.
- **Brightness options:** Specifies the brightness level for your phone display when it is in screen saver mode. This option only applies to your phone if it has a backlight (all 5340 and newer 5330 IP Phones).

**To configure the screen saver on your 5330/5340 IP Phone:**

1. Press  (Applications).
2. Press **Screen Saver**.

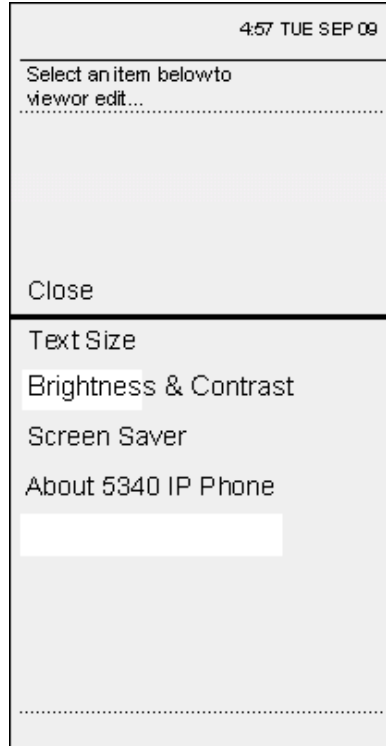

3. Configure your screen saver options:
  - a. Select one of the following screen saver timeout options:
    - 15 minutes
    - 10 minutes
    - 5 minutes
    - 1 minute

- b. If desired, enable the **Display Image** option:
  - o *If you enable the Display Image option*, the screen saver image appears and your backlight dims when your phone enters screen saver mode, as specified by the screen saver timeout setting.
  - o *If you disable the Display Image option*, only your backlight dims (if your phone has a backlight) when your phone enters screen saver mode, as specified by the screen saver timeout setting. This is the default setting.
- c. Configure brightness options if your phone has a backlight (all 5340 and newer 5330 IP Phones).

Options include:

- o **Brightness+**: Increases the brightness of the display when your phone is in screen saver mode.
- o **Brightness-**: Decreases the brightness of the display when your phone is in screen saver mode.
- o **Show Brightness**: Shows the brightness level of the display when your phone is in screen saver mode. The display returns to normal after approximately two seconds.



4. Press **Save**.
5. Press **Close** to exit the Applications menu.

**To wake your phone from screen saver mode:**

Lift the handset or press any button to wake the phone.

## Changing the Text Size on a Display

You can control the size of the text that appears on the display for programmable buttons. This enhancement does not apply to the text size that appears on the display for the menu buttons.

Text size options include:

- **Large text:** Provides one line of basic information for the features and functions programmed for the button. Large text is enabled by default.
- **Small text:** Provides a first line of basic information and a second line of supplemental information for the features and functions programmed for the button.

The table below includes several examples for the large text and small text display options.

Programmable Button	Large Text Example	Small Text Example	Second line provides...
Station Speed Dial	Monica S	Monica S 25598	The station speed-dial number programmed for the button.
System Speed Dial	Chandler TS	Chandler TS 4809619000	The system speed-dial number programmed for the button.
Direct Station Selection (DSS)	Jessica A	Jessica A 28899	The extension number programmed for the user.
Programmable Feature	DND	DND (372)	The feature code that corresponds to the feature programmed for the button.
Intercom Call (IC)	IC	IC Charlie B	The name or number for the other party on the internal call.

### To change the text size on a display:

1. Press  (Applications).
2. Press **Text Size**.

## Changing the Language

Your system administrator can select two of the following languages as the primary and secondary languages to display text.<sup>1</sup>

- American English
- British English
- Spanish

For example, if your system administrator programmed your phone with American English as the primary language, American English is used for display text. You can change the language by selecting the secondary language. Contact your system administrator for more information.

### To change the language:

Dial **301** to select either the primary or secondary language. The display shows text in the selected language.

<sup>1</sup> This feature may or may not be enabled for your system.

## Listening to Background Music

If your system is equipped with a music source, you can listen to background music or system audio (for example, organizational conference calls) through the external speaker.

### To turn on or turn off background music:

Dial **313** (on/off). BACKGROUND MUSIC ON (or OFF) appears.

## Using Programmable Buttons

For quick access, you can assign feature codes, extensions, or speed-dial numbers to your programmable buttons. The new button assignments are self labeled, which means the button labels automatically appear on the Display when the buttons are programmed. You can then press the programmed buttons to activate features or place calls. See “Default Access Codes” and “Default Feature Codes” on [page 16](#) for code lists. You cannot reprogram the default button assignments. See “Programmable Buttons” on [page 6](#).

### To program a button:

1. With the handset on-hook, dial **397**.
2. Press the button that you want to program. If the button is:
  - *not programmed*, UNDEFINED KEY appears.
  - *programmed*, the feature or extension programmed for the button appears.
  - *not programmable*, NON-PROGRAMMABLE KEY appears.
3. Enter the feature code, extension number, or speed-dial code (**0 to 9**) to be assigned to the button.

#### NOTE

Before assigning a speed-dial number to a programmable button, the number must be stored with either a Station or System speed-dial code. See “Using Speed Dial” on [page 24](#).

After you program a button, you can:

- Press the button to place a call to the assigned extension.
- Press the button and then hang up to transfer a call to the assigned extension. If the call is transferred to voice mail you hear repeating double tones.
- Visually monitor the call activity of the assigned extension if the button you assign has a lamp.

The following table describes the lamp signals and the indicated call activity:

Lamp Signals	Description
Continuously Lit	The extension is busy or off-hook.
Slowly flashing	The extension is in Do-Not-Disturb (DND).
Quickly flashing	The extension has a call ringing in.
Continuously flashing	The extension is causing a “Station Off-Hook” system alarm.

## Additional Programmable Buttons

You can also use the Direct Station Selection/Busy Lamp Field (DSS/BLF) unit to add additional programmable buttons to your telephone. You can program buttons the same way as those on the associated telephone as described earlier in this section. Contact your system administrator for details.

## Default Access Codes

The following are default system access codes. If your system uses different codes, record the codes in the “New Code” column for reference.

### Outside Line Access Codes

Code Type	Code	New Code
Emergency Call	911 (999/112 Europe)	
Outgoing Call (Default)	8	
Select Line Group 1 to 208	92001 to 92208	
Automatic Route Selection	92000	

### Extension Numbers

Code Type	Code	New Code
Attendant	0	
Phone Extensions	1000 to 1999	
Hunt Groups	2000 to 2299	

## Default Feature Codes

The following table lists default feature codes. If your system administrator changes any of the default codes, you can record the new codes in the “New Code” column for reference.

<b>NOTE</b>	Most of the following feature codes work when your phone is idle. However, if you are on an active call or if the phone is off-hook, you may need to press  (Special) before you enter the feature code to activate the feature.
-------------	---

#### To delete the characters entered:

Press  (Hold) to move the cursor to the left and delete the characters entered.

#### To cancel the feature:

Press \*.

Feature	Page	Code	New Code
Account Code – Follow Calls	29	391	
Account Code – Optional	29	390	
ACD Agent – Log In	49	326	
ACD Agent – Log In/Out	49	328	
ACD Agent – Log Out	49	327	
ACD Agent – Wrap-up Terminate	50	329	
Agent Help – Reject	50	376	
Agent Help – Request	50	375	
Answer Ringing Call	21	351	

Feature	Page	Code	New Code
Automatic IC Access – On/Off	21	361	
Automatic Trunk Access – On/Off	21	360	
Automatic Trunk Answer	22	350	
Background Music – On/Off	15	313	
Barge-in	52	386	
Call Forward – All Calls	34	355	
Call Forward – If Busy	34	357	
Call Forward – If No Answer	34	356	
Call Forward – No Answer/Busy	34	358	
Call Logging	39	333	
Change Language	14	301	
Conference	37	5	
Default Station	19	394	
Directory	28	307	
Display Time And Date	33	300	
Do-Not-Disturb	45	370	
Do-Not-Disturb – Cancel	45	371	
Do-Not-Disturb – On/Off	45	372	
Do-Not-Disturb – Override	45	373	
Group Listen	38	312	
Handsfree – On/Off	31	319	
Headset – Off	8	316	
Headset – On	8	315	
Headset – On/Off	8	317	
Hold – Individual	32	336	
Hold – System	32	335	
Hookflash (Recall in Europe)	32	330	
Hunt Group – Remove	51	322	
Hunt Group – Remove/Replace	51	324	
Hunt Group – Replace	51	323	
Display Contrast Control	10	303	
Message – Cancel Left Message	44	366	
Message – Delete Message	44	368	
Message – Leave Inter-station Message	43	367	
Message – View Messages	44	365	
Microphone Mute – On/Off	31	314	
Page	47	7	

## Personalizing Your Phone

Feature	Page	Code	New Code
Page Receive – On/Off	47	325	
Personal Call Routing On	35	363	
Personal Call Routing Off	35	362	
Personal Call Routing On/Off	35	364	
Personal Call Routing Handoff	35	388	
Program Buttons	15	397	
Program Station Password	40	392	
Programmable Buttons – Return to Default	19	395	
Queue (Callback) Request	23	6	
Record-A-Call	38	385	
Redial	24	380	
Redirect Call	22	331	
Reminder Message	45	305	
Reminder Message – Cancel	45	306	
Remote Programming	40	359	
Reverse Transfer (Call Pick-Up)	33	4	
Ring Intercom Always – On/Off	31	377	
Ring Tone Selection	10	398	
Station Monitor	52	321	
Station Speed Dial	25	382	
Station Speed Dial – Programming	25	383	
Steal Call	52	387	
System Forward – Off	34	353	
System Forward – On	34	352	
System Forward – On/Off	34	354	
System Speed Dial	26	381	
Switch Keymap	19	399	
Transfer To Hold	32	346	
Transfer To Ring	32	345	
View Programmable Button Assignments	19	396	



---

## Viewing Button Assignments

You can view programmable button (key) feature assignments.

**To view button assignments:**

1. With the handset on-hook, dial **396**. PRESS THE KEY TO REVIEW appears.
2. Press any of the feature buttons to display the assignment.
3. Press **#** or  (Speaker) to exit.

## Resetting Programmable Buttons

You can reset all buttons (keys) that you have programmed to the default assignments. Resetting the programmable buttons does not reset button assignments programmed by the system administrator.

**To reset the feature buttons to the default values:**

With the handset on-hook, dial **395**. FEATURE KEYS DEFAULTED appears.

## Resetting the Phone to the Default Settings

Resetting the phone to the default settings does the following:

- Returns all volume settings to the default levels. See “Changing Volume Levels” on [page 10](#).
- Cancels Background Music. See “Listening to Background Music” on [page 15](#).
- Cancels Callback (queue) requests. See “Requesting a Callback (Queuing the Phone)” on [page 23](#).
- Restores Handsfree Mode. “Using Handsfree Mode” on [page 31](#).
- Cancels Manual Call Forwarding. See “Manual Call Forwarding” on [page 34](#).
- Cancels System Forwarding. See “System Forwarding” on [page 34](#).
- Cancels Do-Not-Disturb (DND). See “Using Do-Not-Disturb (DND)” on [page 45](#).
- Restores Page settings. See “Paging Other System Users” on [page 47](#).
- Resets hunt group calls. See “Hunt Groups” on [page 49](#).

**To reset your phone to the default settings:**

Dial **394**. Station DEFAULTED appears.

## Switching Keymaps

Keymaps are the default button assignments on your phone. Your system may have programmed an alternate keymap, allowing you to switch between keymap assignments. Contact your system administrator for more information.

**To switch between keymaps when your phone is idle:**

With the handset on-hook, dial **399**. The display shows either ALTERNATE (or) STANDARD KEYMAP IS ACTIVE.

**To switch between keymaps during a call:**

Press  (Special), and then dial **399**.



---

# Answering and Placing Calls

The following instructions describe how to answer and place internal and external calls and how to use related features.

**NOTE**

By default, internal (intercom) calls are assigned to the **IC** button, and external calls are assigned to the **Call Key** buttons.

## Answering Calls

Your phone may be preset to automatically answer incoming internal calls in Handsfree Mode. To disable Handsfree Mode, see “Using Handsfree Mode” on [page 31](#). After disabling Handsfree Mode, you can use your handset or headset to answer incoming calls.

**To answer a call:**

Lift the handset, or press  (Speaker) to answer a call while using a headset or to answer a call in Handsfree Mode. See “Using Handsfree Mode” on [page 31](#).

If you are currently on a call, press the flashing **IC** or **Call Key** button to answer a waiting call. See “[Answering Waiting Calls](#)” below.

## Answering Waiting Calls

If you receive a call while you are on another call, you hear a “call waiting” tone, the **IC** or **Call** button flashes, and the display shows the Caller ID information (if available).

**To answer a waiting call:**

Press the flashing **IC** or **Call Key** button. This places the first call on hold and connects you to the waiting call. You can also place the first call on hold before you answer the waiting call. See “[Placing Calls On Hold](#)” on [page 32](#).

## Using Automatic Call Access

Automatic Call Access connects you to incoming internal or external calls when you pick up the handset or press  (Speaker). When Automatic Call Access is turned off, you must press the flashing **IC** or **Call Key** button to answer incoming calls.

**To use Automatic Call Access for incoming IC calls:**

With the handset on-hook, dial **361** to turn on (or off). AUTO IC ACCESS ON (or OFF) appears.

**To use Automatic Call Access for incoming external (trunk) calls:**

With the handset on-hook, dial **360** to turn on or off. AUTO TRNK ACCESS ON (or OFF) appears.

### Redirecting Calls

You can redirect calls to another extension or external number. If you have a 5340 IP Phone, you can use the menu buttons to redirect calls to the following destinations:

- **SEND TO V-MAIL:** Sends the call directly to your voice mailbox. You must have a mailbox to use this destination.
- **IC CALL TO DND:** Places your phone in DND Mode and blocks the call. See “Using Do-Not-Disturb (DND)” on [page 45](#).
- **SEND TO DEST:** Redirects the call to the extension or phone number entered.

**To redirect calls:**

1. While a call is ringing, dial **331** or press the menu button as described above (5340 IP Phones only).
2. If applicable, enter the extension number or press the **Outgoing** button (**8** is the default code), and then enter the external number, or enter the DND code (see [page 45](#)). The call is redirected to the destination specified.

### Using Automatic Trunk Answer

You can use Automatic Trunk Answer to answer incoming external calls for other internal parties who are members of an “Answer Access” list. Your system administrator creates Answer Access lists. Contact your system administrator for Answer Access list extensions.<sup>1</sup>

Automatic Trunk Answer answers calls in the order they are received (that is, the first call received by any extension in the Answer Access list is the first one answered).

**To use Automatic Trunk Answer:**

1. While an incoming external call is ringing at another Answer Access list extension, lift the handset or press  (Speaker).
2. Dial **350** or press the flashing **Trunk <number>** button.

### Placing Calls

The following instructions describe how to place calls and related features.

#### Placing Emergency Calls

 **WARNING**

Contact your system administrator and your local Mitel provider for important information about dialing emergency services before using your phone.

When dialing an emergency number (911 U.S. or 999/112 Europe), you do **not** have to press the **Outgoing** button or enter the Outgoing Call access code (**8** is the default code). The system automatically places emergency calls immediately after you dial the number, even if you do not select an outside line.

---

1. This feature may or may not be enabled for your system.

## Placing Internal Calls

Internal calls are calls placed to other extensions in the system. Internal calls are assigned to the Intercom (IC) button on your phone. Contact your system administrator for a list of extension numbers.

### To place an internal call:

With or without the handset lifted, dial the extension number. If you enter incorrect digits, you can press  (Hold) to move the cursor backward, deleting the last digits entered.

If you are using Handsfree Mode, speak after you hear a double tone.

If there is no answer or if the extension is busy, you can do the following:

- Request a callback (queue). See “[Requesting a Callback \(Queuing the Phone\)](#)” below.
- Camp-on to the busy extension. See “[Using Camp-on](#)” below.
- Leave a message. See “Leaving Messages at Other Extensions” on [page 43](#).

## Requesting a Callback (Queuing the Phone)

When you request a callback (queue the phone), the system calls you when the extension is available and places a call to the phone.

### To request a callback:

If there is no answer or if the extension is busy, press  (Special) followed by **6** or the **QUEUE** menu button (5340 IP Phones only), and then hang up. QUEUE REGISTERED FOR <name> appears. When the extension becomes available, your extension rings.

### To cancel the callback request:

Press **6** or the **CANCEL QUEUE** menu button (5340 IP Phones only). QUEUE REQUEST CANCELED appears.

## Using Camp-on

Camp-on keeps you connected to the called extension until it becomes available. You cannot use Camp-on if the called extension is in DND, or if the call is forwarded to voice mail. See “Using Do-Not-Disturb (DND)” on [page 45](#).

### To use Camp-on:

Stay on the line and wait for the extension to become available. Do not hang up. If Camp-on is enabled, you hear Music-on-Hold while you are waiting.

### Placing External Calls

The following sections describe features used when placing external calls.

#### To place an external call:

1. Press the **Outgoing** button, an unlabeled **Call Key** button, or enter the Outgoing Call access code (**8** is the default code).
2. Dial the number.

#### NOTES

If you cannot place an external call because all outgoing lines are busy, you can request a callback, which prompts the system to contact you when a line becomes available. See “Requesting a Callback (Queuing the Phone)” on [page 23](#) “.

If you are prompted for an account code (indicated by a single beep), you must enter an account code before you can place your call. See “Using Account Codes” on [page 29](#).

Depending on system configuration, you may also be able to use one of the following methods to select an outgoing line:

- Enter the Select Line Group feature code. The default codes are 92001 to 92208.
- Enter the Automatic Route Selection (ARS) feature code. The default code is 92000.

Contact your system administrator for more information about using Select Line Group or ARS access codes.

### Redialing a Number

You can quickly redial the last *external* number dialed. You cannot redial extension numbers.

#### To use Redial:

With or without the handset lifted, press  **REDIAL**. The system automatically selects a line and dials the number.



### Using Speed Dial

You can use speed dial to quickly dial stored phone numbers. Speed-dial numbers are either stored in the system (System Speed Dial), or in your phone (Station Speed Dial).

### Using System Speed Dial

Your system administrator assigns Speed-Dial location numbers, which are available to anyone in the system. Contact your system administrator for more information.

#### To view or dial System Speed-Dial numbers:

1. Dial **381**. REVIEW SYS SPEED # <code range> appears.
2. Do one of the following:
  - Press  (Up) or  (Down) to scroll through the speed-dial locations.
  - Enter the speed-dial location (**000** to **999** or **0000** to **4999**).
3. Press **#** or the **ACCEPT** menu button (5340 IP Phones only) to dial the number.



## Using Station Speed Dial

You can use Station Speed Dial to store phone numbers for your personal use. Other system users do not have access to your Station Speed-Dial numbers.

### Storing Station Speed-Dial Numbers

You can store up to 10 station Speed-Dial numbers.

#### To store a Station Speed-Dial number:





1. With the handset on-hook, dial **383**. PROGRAM STN SPD (0-9) OR SCROLL appears.
2. Do one of the following:
  - Press  (Up) or  (Down) to scroll through the speed-dial locations.
  - Enter the speed-dial location (**0 to 9**).

Press **#** or the **ACCEPT** menu button (5340 IP Phones only) to select the location.
3. Enter the name of the speed-dial contact (up to 10 characters). For dialpad character descriptions, see “Using the Dialpad Buttons to Enter Characters” on [page 25](#).
4. Press **#** or the **ACCEPT** menu button (5340 IP Phones only) to save the name.
5. Enter the extension number or external number. If you are storing an external number, enter the Outgoing Call access code (**8** is the default code) before you enter the number. Do not use hyphens or colons in stored speed-dial numbers.
6. Press **#** or the **ACCEPT** menu button (5340 IP Phones only) to save the location. STN SPD BIN # <number> UPDATED appears.

### Using the Dialpad Buttons to Enter Characters

You can use the dialpad buttons to enter text or numbers for features such as Do-Not-Disturb (see [page 45](#)) and Station Speed Dial (see [page 25](#)).

The following are guidelines when entering dialpad characters:



- Press  (Message) to switch from Alpha Mode to Numeric Mode. The  (Message) button stays lit in Alpha Mode and is off in Numeric Mode.
- Press  (Hold) to move the cursor to the left and delete characters.
- Press  (Transfer) to move the cursor to the right.
- In Numeric Mode, press **#** for a hyphen (-).
- In Numeric Mode, press **\*** for a colon (:).
- Press **#**,  (Speaker), or lift and replace the handset to save entries.

### To use the dialpad to enter characters:

Press the dialpad buttons as shown in the following table.

Button	Characters Represented (in Alpha Mode)
0	@ : . , 0
1	- & ( ) 1
2	A B C ' 2
3	D E F ! 3
4	G H I * 4
5	J K L # 5
6	M N O ñ 6
7	P Q R S 7
8	T U V ? 8
9	W X Y Z 9



For example, to enter **May 31**, you could use the following sequence:

1. In Alpha Mode (☒ [Message] button is lit), press **6** once to enter an “M.”
2. Press **2** once to enter an “A.”
3. Press **9** three times to enter a “Y.”
4. Press  (Transfer) to enter a space.
5. Press ☒ (Message) to switch to Numeric Mode.
6. Press **3**.
7. Press **1**.
8. Press  (Speaker), #, or lift the handset to save the entry.

## Dialing Station Speed-Dial Numbers

### To dial a Station Speed-Dial number:

Do one of the following:

- Dial **382**, and then enter the Station Speed-Dial location number (**0** to **9**). The system dials the number.
- Press  (Up) or  (Down) to scroll through the speed-dial locations, and then press # to select the location and dial the number.





#### NOTE

You can also use a Station Speed-Dial button assigned to the number you are dialing. See “Assigning Speed-Dial Entries to Programmable Buttons” on [page 27](#).



## Deleting Speed-Dial Entries

### To delete a Station Speed-Dial entry:

1. With the handset on-hook, dial **383**. PROGRAM STN SPD (0-9) OR SCROLL appears.
2. Do one of the following:
  - Press  (Up) or  (Down) to scroll through the speed-dial locations.
  - Enter the speed-dial location (**0** to **9**).
3. Press **#** or the **ACCEPT** menu button (5340 IP Phones only) to select the location.
4. Press  (Hold) repeatedly until the name is erased, and then press **#** or the **ACCEPT** menu button (5340 IP Phones only) to continue.
5. Press  (Hold) repeatedly until the number is erased, and then press **#** or the **ACCEPT** menu button (5340 IP Phones only). STN SPD BIN # <number> UPDATED appears.



## Assigning Speed-Dial Entries to Programmable Buttons

You can assign Station or System Speed-Dial numbers to your programmable buttons.

### NOTE

Before assigning the speed-dial number to a programmable button, make sure the number has either a Station or System Speed-Dial code assigned to it.

### To program a System/Station Speed-Dial button:



1. With the handset on-hook, dial **397**. PRESS THE BUTTON TO PROGRAM appears.
2. Press the feature button that you want to program as a speed-dial button.
3. Dial **382** (Station Speed Dial) or **381** (System Speed Dial).
4. Do one of the following:
  - Press  (Up) or  (Down) to scroll through the speed-dial locations.
  - Enter the speed-dial location (**0** to **9** for Station Speed-Dial or **000** to **999** or **0000** to **4999** for System Speed Dial), or select the menu button designation from the display (5340 IP Phones only).

## Using the Directory

You can use the Directory to find internal or external contacts or find and activate system features. The directory uses Intelligent Directory Search (IDS), which is similar to the “text on 9 keys” (T9) predictive search feature used for mobile phones. The Directory has the following three subdirectories:

- **Intercom:** Find and dial internal numbers.
- **Outside:** Find and dial external numbers listed in the company directory.
- **Feature:** Find and activate system features.

When searching the directory, dialpad buttons can represent several characters, as shown in the following table. As you enter characters, the entries that best match the characters entered appear. The system connects the character sequence to possible directory matches. For example, to find the name “Jones,” dial **56637**.

Button	Characters Represented
0	0
1	1
2	2 A B C a b c Ç â ä à ç Ä Á á
3	3 D E F d e f é ê ë è É
4	4 G H I g h i î ï í
5	5 J K L j k l
6	6 M N O m n o ô õ ò Ö ó ñ Ñ
7	7 Q P R S q p r s
8	8 T U V t u v ü û ù Ü ú
9	9 W X Y Z w x y z ý
 (Up)	Scroll to next entry
 (Down)	Scroll to previous entry
*	Cancel search
#	Activate selection
 (Hold)	Move the cursor to the left, deleting existing characters

See [page 29](#) for detailed instructions on using the directory.

**To search for a directory name or feature:**

1. Dial **307**, and then press one of the following:
  - **1** for the IC directory.
  - **2** for the Outside directory.
  - **3** for the Feature directory.
  - The directory menu button (**IC**, **OUTSIDE**, or **FEATURE**—5340 IP Phones only).
2. Press the dialpad buttons to enter (up to 20) characters. See the table on [page 28](#) for dialpad button character descriptions.
3. Press ▲ (Up) or ▼ (Down) or the >> (Next) or << (Previous) menu buttons (5340 IP Phones only) to scroll through the entries.

**NOTE**

The IC directory may display two similar entries, one without an asterisk and one with an asterisk. The entry without an asterisk is the primary extension—the entry with an asterisk is a secondary extension.

4. Press **#** (or the menu button next to the entry [5340 IP Phones only]) while the display shows the entry to dial a number or activate a feature code.

## Using Account Codes

Account codes record information for telephone record reports. You may be required to enter account codes when placing calls. Contact your system administrator for more information about using account codes.

There are three types of account codes:

- **Standard account codes:** Automatically entered into the telephone record report whenever you place a call.
- **Forced account codes:** Entered before you can place an outside call.
- **Optional account codes:** Entered at any time during a call.

**To enter an optional account code:**

1. While off-hook, press ⊗ (Special), and then dial **390**.
2. Enter the optional account code, and then press **#**.

**To set an account code for all calls placed from your phone:**

Dial **391** followed by the account code, and then press **#**. This code is used for all calls made from your phone until it is disabled.

**To disable the code:**

Dial **391**, and then press **#**. ACCOUNT CODE CLEARED appears.



---

# Call Features

The following sections describe call-related features.

## Using Handsfree Mode

You can use Handsfree Mode to activate the speakerphone.

### NOTES

The Ring Intercom Always feature prevents calls from being answered in Handsfree Mode (see the following section).

You cannot use Handsfree Mode if you are using a headset, or if you have more than one phone assigned to an extension number.

#### To use Handsfree Mode:

With the handset on-hook, dial **319**. HANDSFREE MODE ON appears. Dial **319** again to turn Handsfree Mode off.

## Using Ring Intercom Always

If another extension has Handsfree Mode enabled for incoming internal calls (see the previous section), you can use Ring Intercom Always to override Handsfree Mode on the extension, requiring the called party to pick up the handset to answer your call.

#### To override Handsfree Mode for the current call:

1. Before you enter the extension number, press **#**. RING EXTENSION NUMBER appears.
2. Dial the extension number.

#### To use Ring Intercom Always to always send non-handsfree calls:

With the handset on-hook, dial **377**. RING IC ALWAYS ON appears. Dial **377** again to turn Ring Intercom Always off.

## Using Mute

You can use Mute to temporarily turn off your microphone, preventing the other party on the call from hearing you.

#### To mute or unmute the microphone:

While on a call, press  (Mute). MICROPHONE MUTE ON appears. When the microphone is muted, the Mute button lamp is lit. Press  (Mute) again to unmute.

## Placing Calls On Hold

You can place calls on either Individual Hold or System Hold.

- **Individual Hold:** Places an internal or external call on hold at your phone.
- **System Hold:** Places an external call on hold in the system. You can then pick up the call from any phone that indicates a flashing Call button for the call, including the phone that placed it on hold.



### To place a call on Individual Hold:

1. Press  (Hold). ENTER EXTENSION NUMBER appears.
2. Hang up or place another call.

### To place an outside call on System Hold:

1. Press  (Special), and then dial **335**. ENTER EXTENSION NUMBER appears.
2. Hang up or place another call.

### To return to a call that is on hold:

Press  (Hold), and then lift the handset or press  (Speaker). <Caller> WAS HOLDING appears.

## Entering a Hookflash

Some telephone companies require you to enter a hookflash (a quick hang up and release) for feature access.

### To enter a hookflash:

While off-hook, press  (Special), and then dial **330** or press the **FLASH** menu button (5340 IP Phones only).

## Transferring Calls

You can transfer calls to other extensions or external numbers. You can also transfer conference calls. See “Transferring a Conference” on [page 37](#) for more information.

### Transferring Calls to Other Extensions

#### To transfer a call to another extension:

1. While on the call, press  (Transfer), and then enter the extension number.
2. Do one of the following:
  - Wait for an answer, announce the call, and then hang up. If the extension is unavailable, press the flashing **IC** or **Call Key** button to return to the caller.
  - Hang up to transfer the call and disconnect the call from your phone.

#### NOTE

If your system administrator has enabled Transfer-on-Connect for your phone, you are automatically connected to calls transferred to your extension after the transferring party hangs up. If this option is turned off, you must press a **Call Key** button to answer calls transferred to your extension.

---

## Transferring Calls to External Numbers

### To transfer a call to an external number:

1. While on the call, press  (Transfer).
2. Press the **Outgoing** button or the Outgoing Call access code (the default code is **8**) to select an outside line.
3. Dial the phone number.
4. Do one of the following:
  - Wait for an answer, announce the call, and then hang up. If the extension is unavailable, press the flashing **Call Key** button to return to the caller.
  - Hang up to transfer the call and disconnect the call from your phone.

## Using Reverse Transfer

You can use Reverse Transfer (Call Pick Up) to answer calls that are ringing or holding at other extensions. For example, if you receive a call while you are away from your desk, you can pick up the call from another extension.

### To use Reverse Transfer:

1. Lift the handset, and then press **4**. ENTER EXTENSION NUMBER appears.
2. Dial the extension or hunt group number where the call is ringing or holding. The call is transferred to the phone you are using and you are connected to the caller.

## Viewing Your System Information

If you are on a call, you can temporarily view your user information (your user name and your extension number) and the date and time.

### To display your user information and the date and time:

Press  (Special), and then dial **300**.

## Viewing Caller ID Information

If you are currently connected to an external caller with Caller ID, you can toggle between the caller's name and number. If the name is unavailable, CANNOT ACCESS FEATURE appears.

### To show the outside party's name/number:

Press  (Special), and then dial **379**.

## Forwarding Calls

You can use Manual Call Forwarding (see [page 34](#)) or System Forwarding (see [page 34](#)) to forward calls.

### Manual Call Forwarding

The following table describes Manual Call Forwarding options.

Call Forward Feature	Description	Code/Menu Button (5340 IP Phones only)
Call Forward All Calls	All incoming calls are forwarded.	355 ALL
Call Forward if no Answer	All incoming calls are forwarded if not answered. (The timer is set by the system administrator.)	356 NO ANSWER
Call Forward If Busy	When your phone is busy, all incoming calls are forwarded without ringing.	357 BUSY
Call Forward If No Answer/Busy	All incoming calls are forwarded if your phone is busy, or if you do not answer.	358 NO ANSWER/BUSY

#### To use Manual Call Forwarding:

1. Press the **Fwd All** button (5320/5330 IP Phone) or **Forward** button followed by the menu button designation (5340 IP Phone), or dial the Manual Call Forwarding feature code from the previous table. ENTER FORWARD DEST appears.
2. Enter the extension number, or press the **Outgoing** button or the **Outside** menu button (5340 IP Phones only), and then dial the telephone number. On the 5340 IP Phone, you can press the **MESSAGE CENTER** menu button to forward calls to the Message Center (voice mailbox). FWD ALL CALLS TO <number> appears.

#### To cancel a Manual Call Forwarding request:

- **5320/5330 IP Phone:** Press the **Fwd All** button, and then press # (Speaker), or lift the handset.
- **5340 IP Phone:** Press **Forward** button, and then press the **FWD OFF** menu button.

## System Forwarding

You can use System Forwarding to route calls based on the type of call and the idle or busy status of your phone. You cannot program the System Forward destination. You can only turn it on or off. Contact your system administrator for more information.

#### To turn on or turn off System Forwarding:

Dial **354**. SYSTEM FORWARD ON appears. Dial **354** again to turn System Forwarding off.



## Using Personal Call Routing

When you enable Personal Call Routing on your phone, your incoming calls are automatically routed to one or more preprogrammed associated destinations according to the routing steps programmed for you.

Typically, your desk phone is configured to be your main extension. You may be programmed for up to five associated destinations including:

- softphone
- home IP phone
- voice mail
- mobile phone
- home phone

Your desk phone, softphone, home IP phone and voice mail extensions are already programmed in the system, so your system administrator can easily include them in your routing steps. To include your mobile and home phone numbers in your routing steps, you will need to provide these numbers to your system administrator.

Personal Call Routing also includes the Handoff feature, which includes the following functions:

- **Push:** The Handoff “push” function allows you to move an active call from your main extension, typically your desk phone, to an associated destination without disconnecting audio. The push function is useful if you are leaving the work area, but want to remain connected to an active call. The push function rings all associated destinations (except voice mail) and you select which device to use to answer the call. When you answer the call, you are immediately connected to the other parties at the new destination. When the call is switching over to the new destination, there may be a momentary break in audio, which may be noticeable to the other parties on the call.
- **Pull:** The Handoff “pull” function allows you to pull a call that was previously routed to your mobile or home phone back to the main extension. The pull function is useful if you answer a call on your mobile phone and then return to your desk. After you pull a call back to the main extension, the call is connected immediately and you can then access system features such as conference, hold, and transfer.

**NOTE**

The Handoff feature is only supported on your main extension, typically your desk phone. However, if you share a desk phone with one or more coworkers and your main extension is a phantom extension, you cannot use the Handoff feature.

Personal Call Routing includes the following feature codes:

- Personal Call Routing On: **363**
- Personal Call Routing Off: **362**
- Personal Call Routing On/Off: **364**
- Personal Call Routing – Handoff (push and pull): **388**

The following call types do not follow Personal Call Routing:

- Hunt group calls
- Hunt group announcement/overflow calls
- Transfer recalls, Hold recalls, Conference recalls, and Attendant recalls

**NOTE**

A recall occurs when a feature cannot be completed or the feature times out, and the call returns to the originating extension. For example, a holding call will recall the extension where it was placed on hold when the hold timer expires.

When you enable Personal Call Routing, your incoming calls are routed as specified by the routing type programmed for you by your system administrator. The table below provides descriptions for the default routing types.

Routing Type	Description
Mobile Twinning	Calls simultaneously ring your desk phone and mobile phone, before going to voice mail.
Delayed Mobile Twinning	Calls ring your desk phone first, and then ring both your desk phone and mobile phone, before going to voice mail.

Check with your system administrator to see which routing type has been programmed for you. Your administrator can modify these routing types by adding or removing routing steps, adding or removing destinations, and changing the ring timers, if required.

To ensure that calls are routed correctly to your mobile and home phones, inform your system administrator if either of these phone numbers change.

**To enable Personal Call Routing:**

Dial **363** or **364**. PERSONAL ROUTING ON appears on the display.

**To disable Personal Call Routing:**

Dial **362** or **364**. PERSONAL ROUTING OFF appears on the display.

**To answer a call routed to your mobile or home phone:**

1. Answer the call when it rings your phone. After you speak, the Personal Call Routing prompt is played.
2. Do one of the following:
  - Press # to accept the call.

**NOTE**

You do not need to wait for the prompt to accept the call. You can accept the call immediately by pressing the # button.

- Press \* to send the call to the voice mailbox associated with your main extension (not your mobile phone or home phone voice mailbox). If you do not have a voice mailbox, the “Press \*...” prompt is not played and the call is routed to your main extension.

If you hang up, the call continues to follow your programmed routing steps.

**To use the Personal Call Routing – Handoff “push” feature:**

1. While on an active call at your phone, press **ⓧ** (Special), and then dial **388**. HANDOFF IN PROGRESS appears on the display and the call rings all of your associated destinations (except voice mail).
2. Answer the call at one of your associated destinations. For mobile and home phones, press # to accept the call.

**To use the Personal Call Routing – Handoff “pull” feature:**

While on an active call on an associated destination device, lift the phone handset and dial **388**. A confirmation tone is played and the call is pulled back to your phone.

**NOTE**

If you enter the handoff feature code (388) and the display shows NO CALL TO HANDOFF, the call cannot be handed off (see [page 63](#)).

**To cancel the Personal Call Routing – Handoff feature:**

While the handoff is in-progress, press **ⓧ** (Special), and then dial **388**. HANDOFF CANCELLED appears on the display for your main extension.

## Placing Conference Calls

You can place a conference call with up to three internal or external parties (for a total of four parties, including yourself).

### To place a conference call:

1. While on the first call, press the **Conference** button to place the call on hold. CALL NEXT PARTY TO CNF appears.
2. Place a call to the next conference party (for external calls, press the **Outgoing** button or the Outgoing Call access code [8 is the default code], and then dial the number).
3. After the party answers, announce the conference, and then press the **Conference** button to place the call on hold. If necessary, repeat this step to add the remaining conference party.
4. Press the **Conference** button again or the **CONNECT TO CNF** menu button (5340 IP Phones only) to start the conference. CNF IN PROGRESS appears.

## Adding a Conference Party

You can add a conference party during the conference.

### To add a conference party:

1. Press the **Conference** button or the **ADD PARTY** menu button (5340 IP Phones only). This leaves the conference parties connected.
2. Place a call to the party to be added to the conference, and then announce the conference. Press the **Conference** button (twice) or the **CONNECT TO CNF** menu button (5340 IP Phones only) to add the party and rejoin the conference.

## Transferring a Conference

You can transfer an existing conference to another extension.

### To transfer a conference:

1. During the conference, press  (Transfer), and then dial the extension number.
2. Announce the conference (if desired), and then hang up. CONFERENCE TFR from <name> appears on the called party's display. The party must then press the flashing **Conference** button to connect to the conference.

## Dropping Out of a Conference

You can drop out of a conference and return to the conference later.

### To drop out of a conference:

Press the **Conference** button or  (Hold), and then hang up. ENTER EXTENSION NUMBER appears. This removes you from the conference but leaves the other parties connected.

### To return to the conference:

Press the flashing **Call Key** button. CONFERENCE WAS HOLDING appears, and you are reconnected to the conference.

## Ending a Conference and Placing all Parties on Hold

You can end a conference and place all conference parties on Individual Hold, allowing you to toggle between the held parties and speak to one party at a time.

### To end a conference and place all parties on Individual Hold:

Press the **Conference** button, and then press  (Hold). CONFERENCE PARTIES ON HOLD appears.

### To toggle between the held callers:

Press  (Hold) twice for internal parties or the applicable **Call Key** button for external parties.

## Using Record-A-Call

### NOTE

This feature is not supported for peer-to-peer (P2P) calls. Contact your system administrator for more information.

You can use Record-A-Call to record an ongoing call as a mailbox message.<sup>1</sup> You can then retrieve the message from your voice mailbox. The Record-A-Call feature stays active after the other party hangs up, so you can add to the recorded call with your own message.

### To use Record-A-Call:

1. While on a call, press  (Special), and then dial **385**, or press the **RECORD-A-CALL** menu button (5340 IP Phones only). REQUESTING RECORD-A-CALL appears.
2. Enter the voice mailbox number where you want the recording to be saved. RECORD-A-CALL IN PROGRESS appears, and both you and the calling party hear a confirmation tone (if enabled).

### NOTE

Your system administrator can assign the Record-a-Call voice mailbox destination. If so, you do not need to enter the voice mailbox number.

### To stop Record-A-Call:

Do one of the following:

- Press  (Special), and then dial **385**.
- Press the **CANCEL RECORDING** menu button (5340 IP Phones only).
- Hang up.

## Using Group Listen

You can use Group Listen to activate the speaker while you use the handset or headset to continue speaking. This allows other people to hear the other party on the call while the other party can only hear you (through the handset microphone). You cannot use Group Listen in Handsfree Mode.

### To use Group Listen:

While on a call, press  (Special), and then dial **312**. GROUP LISTEN ON appears, and you hear a confirmation tone. The other party does not hear the confirmation tone. Dial **312** again to turn Group Listen off.

---

1. This feature may or may not be enabled for your system.

---

## Using Call Logging

Your call logs are records of your most recent missed, received, and dialed calls. A maximum of 20 entries are stored in each call log.<sup>2</sup>

You can use Call Logging to:

- View recent call activity.
- View caller ID information.
- Return or redial calls.

### To use Call Logging:

1. Dial **333** or the **LOGS** menu button (5340 IP Phones only).
2. Select one of the following options:
  - Press **1** (MISS) or the **MISSED CALLS** menu button (5340 IP Phones only) for missed calls.
  - Press **2** (RCV) or the **RECEIVED CALLS** menu button (5340 IP Phones only) for received calls.
  - Press **3** (DL) or the **DIALED CALLS** menu button (5340 IP Phones only) for dialed calls.
  - Press **4** (CLR) or the **CLEAR LOGS** menu button (5340 IP Phones only) to clear all entries.
3. Press **▲** (Up) or **▼** (Down) or the **>>** (Next) or **<<** (Previous) menu buttons (5340 IP Phones only) to scroll through the entries.

The display shows the party's name and the extension or outside number (if available) and the date and time.

If no Caller ID information is available, UNKNOWN CALLER appears.

### To return a call or redial a number listed in a call log:

Press **#** or the **CALL NOW** menu button (5340 IP Phones only) while the display shows the number.

### To delete individual call log entries:

Press **0** or the **DELETE** menu button to delete the displayed entry, or press the **DEL ALL** menu button (5340 IP Phones only) to delete all entries in the current call log.

---

2. This feature may or may not be enabled for your system.

## Using Secondary Extension Buttons

Secondary Extension buttons must be programmed by your system administrator. You can use programmable buttons as “secondary extensions.” Secondary Extensions are assigned to other extensions in the system (primary extensions) Because Secondary Extension buttons are programmed by the system administrator, you cannot change the buttons (for example, assign features to the buttons).

When programmed, you can use Secondary Extension buttons to:

- Place an internal call to the primary extension.
- View the call activity at the primary extension.
- Transfer calls to the primary extension.
- Answer a call that is ringing or holding on any **Call Key** button at the primary extension.

### NOTES

The system administrator must set up the **Call Key** buttons for internal calls or you cannot use Secondary Extensions at the primary extension.

You can use Secondary Extension buttons to notify you when a given number of calls are waiting at the primary extension.

If a Secondary Extension button is flashing (the primary extension has an incoming call), you can press # before you press the flashing Secondary Extension button to call the primary extension and not answer the incoming call.

## Remote Programming

You can use Remote Programming to access the DND, Call Forwarding, and Personal Call Routing features from another system phone or an external phone.<sup>3</sup>

### NOTE

A Direct Inward System Access (DISA) number is required to use Remote Programming from an external phone. Contact your system administrator for more information.

## Entering a Remote Programming Password

Before using Remote Programming, you should enter a new password.

**To enter a Remote Programming password:**

1. Dial **392**. ENTER PASSWORD appears.
2. Enter your current password (the default password is your extension number), followed by #. CHANGE PASSWORD TO appears.
3. Enter the new password followed by #. VERIFY PASSWORD appears.
4. Enter the new password again followed by #. DATABASE UPDATED appears.

To change the station password from another phone, see “Using Remote Programming to Change the Password” on [page 41](#).

---

3. This feature may or may not be enabled for your system.

---

## Using Remote Programming to Change the Password

You can use Remote Programming to change the station (phone) password.

### To use Remote Programming to change the station password:

1. Do one of the following:
  - Call your DISA number (provided by your system administrator). If necessary, enter your (DISA) password.
  - Use any phone on the system.
2. Dial **359**.
3. Enter your extension number.
4. Enter your password followed by **#**.
5. Dial **392**.
6. Enter the new password followed by **#**.
7. Enter the new password again followed by **#**.

## Using Remote Programming to Change DND Settings

See “Using Do-Not-Disturb (DND)” on [page 45](#) for more information about using DND.

### To use Remote Programming to turn on DND:

1. Do one of the following:
  - Call your DISA number (provided by your system administrator). If necessary, enter your (DISA) password.
  - Use any phone on the system.
2. Dial **359**.
3. Enter your extension number.
4. Enter your password followed by **#**.
5. Dial **370**.
6. Enter the DND message number (01 to 20), and then enter the second-line message text (if applicable).

### To use Remote Programming to turn off DND:

Follow steps 1 through 4 above, and then dial **371**.

## Using Remote Programming to Forward Calls

See “Manual Call Forwarding” on [page 34](#) for more information about Manual Call Forwarding.

### To use Remote Programming to turn on Manual Call Forwarding:

1. Do one of the following:
  - Call your DISA number (provided by your system administrator). If necessary, enter your (DISA) password.
  - Use any phone on the system.
2. Dial **359**.
3. Enter your extension number.
4. Enter your password followed by **#**.
5. Dial one of the following Call Forwarding feature codes:
  - **355** (All)
  - **356** (No answer)
  - **357** (Busy)
  - **358** (No Answer/Busy)
6. Enter either an extension number or (8) followed by a telephone number.

### To turn off Call Forwarding:

Dial **355**, and then hang up.

## Using Remote Programming for Personal Call Routing

See “Using Personal Call Routing” on [page 35](#) for more information about Personal Call Routing.

### To use Remote Programming to enable Personal Call Routing:

1. Do one of the following:
  - Call your DISA number (provided by the system administrator). If necessary, enter your DISA password.
  - Use any phone on the system.
2. Dial **359**.
3. Enter your extension number.
4. Enter your password followed by **#**.
5. Dial **363** (Personal Call Routing On).

### To use Remote Programming to disable Personal Call Routing:

Follow steps 1 - 4 above, dial **362** (Personal Call Routing Off), and then hang up.



# Messages

This section describes the following system messaging features:

- **Inter-station messages:** Inter-station messages are alerts sent to your phone by other internal parties, notifying you to contact the party who left the message. The  (Message) button and Message/Ring Indicator flash to notify you of the new message. You can then either delete the message or reply to the message, which automatically places a call to the party who left the message.
- **Do-Not-Disturb (DND) messages:** Messages that other internal parties see when your phone is in DND. See “Using Do-Not-Disturb (DND)” on [page 45](#).
- **Reminder Messages:** Messages that you can use to notify yourself of upcoming appointments, meetings, and so on. See “Using Reminder Messages” on [page 46](#).
- **Pages:** Announcements sent over phone speakers or external speakers. See “Paging Other System Users” on [page 47](#).
- **Voice messages:** System voice mail messages.

## NOTE

Because a variety of voice mail products work with the 5000 CP, this guide does not include voice mail instructions. For voice mail instructions, refer to the voice mail user guide for your system. For example, refer to the *Enterprise Messaging, Basic Voice Mail, and Embedded Voice Mail Card User Guide*, part number 835.3205, or the *Mitel NuPoint Unified Messaging User Guide* on the [Mitel Web site](http://edocs.mitel.com) (<http://edocs.mitel.com>). Contact your system administrator for more information about your voice mail system.

## Leaving Messages at Other Extensions

You can leave inter-station or voice mail messages for other internal parties.

### To leave an inter-station or voice message for a busy IC extension:

1. Press  (Message) or the **LEAVE MESSAGE** menu button (5340 IP Phones only). HANG UP OR WAIT FOR MSG CENTER appears.
2. Do one of the following:
  - Hang up to leave an inter-station message. MESSAGE LEFT FOR <name> appears.
  - Stay on the line to connect to the message center (usually voice mail).

### To leave an inter-station message without placing an internal call:

1. Dial **367** (Leave Message), or press  (Message), and then press the **LEAVE MESSAGE** menu button (5340 IP Phones only). LEAVE MESSAGE ON EXTENSION appears.
2. Enter the extension number. MESSAGE LEFT FOR <name> appears.

# Viewing and Responding to Messages

When you have waiting messages, the  (Message) button and Message/Ring Indicator flash and the display shows the number of waiting messages.



**NOTE**

If your handset or speakerphone is off-hook when you view an inter-station message, you automatically call the party who left the message.

The display shows new messages as follows:

- Inter-station messages sent by other internal parties are indicated by the party's programmed user name.
- Voice messages are indicated by FROM MBOX <your extension number>.

**To view or respond to messages:**

1. With the handset on-hook, press  (Message) or the **VIEW MESSAGE** menu button (5340 IP Phones only). Messages are displayed as first in/first out. If there is more than one message, you can repeatedly press  (Message) to scroll through the messages.
2. When the desired message is displayed, press #, or lift the handset for privacy, and then press # to respond. [If your handset is off-hook and you press  (Message), you automatically place a call to the party or message center who left the message.]

## Canceling Messages Left at Other Extensions

You can cancel messages left at other extensions.

**To cancel a message left at another extension:**

1. Dial **366** or press  (Message), and then press the **CANCEL MESSAGE** menu button. CANCEL MESSAGE ON EXT # appears.
2. Enter the extension number where you left the message. MESSAGE CANCELED FOR <name> appears.

## Deleting Waiting Inter-Station Messages

You can delete waiting inter-station messages.

**NOTE**

To delete waiting voice messages, you must connect to your voice mailbox.

**To delete waiting inter-station messages:**

1. Press  (Message) or the **VIEW MESSAGE** menu button (5340 IP Phones only). MSG <message information> appears.
2. Press \* or the **DELETE** menu button (5340 IP Phones only) to delete the displayed message.

## Using Do-Not-Disturb (DND)

You can use DND to stop calls and pages to your extension. When activated, internal calling parties see your selected DND message. DND does not block queue callbacks, recalls, and incoming external calls. The following table shows the 20 default DND messages. If your system administrator changes your DND messages, you can record the new messages in the “New Message” column for reference.

Code	Default Message	New Message	Code	Default Message	New Message
01	Do-Not-Disturb		11	Out of Town 'Til	
02	Leave a Message		12	Out of Office	
03	In Meeting Until		13	Out Until	
04	In Meeting		14	With a Client	
05	On Vacation/ Holiday 'Til		15	With a Guest	
06	On Vacation/ Holiday		16	Unavailable	
07	Call Me At		17	In Conference	
08	At the Doctor		18	Away from Desk	
09	On a Trip		19	Gone Home	
10	On Break		20	Out to Lunch	

You can enter a second line of text (up to 20 characters) for DND messages. For example, if you select IN MEETING UNTIL, you can enter “3:30” on the second line. When other internal parties try to call you, their displays show “IN MEETING UNTIL 3:30.”

### To turn on DND:

1. Press the **DND** button. SELECT DND MSG # (01-20) appears.
2. Do one of the following:
  - Press ▲ (Up) or ▼ (Down) to scroll through the messages.
  - Enter the two-digit number for the DND message from the preceding table.
  - Press the **SCROLL** menu button (5340 IP Phones only), and then press the **PREVIOUS** or **NEXT** menu buttons to scroll through the list.
3. If applicable, enter the additional text for the DND description. See “Using the Dialpad Buttons to Enter Characters” on [page 25](#) for dialpad character descriptions.
4. Press  (Speaker) or the **ACCEPT** menu button (5340 IP Phones only).

### To turn off DND:

Press the DND button, or press the DND menu button (5340 IP Phones only), and then press DND OFF. DO-NOT-DISTURB OFF appears.

## Using Reminder Messages

You can use Reminder Messages to alert you at a selected time, up to 24 hours in advance. At the selected time, the Reminder Message signals you with eight short tones and your display shows the message, even if you are on a call.

The following table shows the 20 default Reminder Messages. If your system administrator changes your Reminder Messages, you can record the new messages in the “New Message” column for reference.

Code	Default Message	New Message	Code	Default Message	New Message
01	Meeting		11	Call Engineering	
02	Staff Meeting		12	Call Marketing	
03	Sales Meeting		13	Call Accounting	
04	Cancel Meeting		14	Cancel DND	
05	Appointment		15	Cancel Call Fwd	
06	Place Call		16	Take Medication	
07	Call Client		17	Make Reservation	
08	Call Customer		18	Review Schedule	
09	Call Home		19	Lunch	
10	Call Corporate		20	Reminder	

### To set a Reminder Message:

1. With the handset on-hook, dial **305**. SELECT REMINDER MESSAGE # (01-20) appears.
2. Do one of the following:
  - Enter the two-digit number for the message from the table above.
  - Press ▲ (Up) or ▼ (Down) to scroll through the messages.
3. Press # or the **ACCEPT** menu button (5340 IP Phones only) to select the message.
4. Enter the time you wish to receive the message in hours and minutes (for example, **0900** or **900** for **9:00**). Then press #. The display shows the Reminder Message state.

*If your system is set for 24-hour format, you must enter the applicable time (1400 = 2:00 P.M.).*

*If your system is set for 12-hour display format, press 1 for A.M. or 2 for P.M.*

### To cancel all Reminder Message requests:

With the handset on-hook, dial **306**. REMINDER MSGS CANCELED appears.

### To clear a received Reminder Message:

With the handset on-hook, press **\***.

## Paging Other System Users

You can place page announcements through phone speakers or external speakers (if applicable). Your system may use page zones to prevent announcements from transmitting through every phone in the system. Each page zone contains a different combination of extensions and external paging equipment.

Contact your system administrator for page zone information. You can use the following table to save the page zone information for future reference.

Page Zone Name	Number	Description

## Placing a Page Announcement

**To place a page announcement:**

1. Press **7**.
2. Enter the page-zone number (**0** to **9**).
3. Wait for the tone, make your announcement, and then hang up.

## Enabling or Disabling the Paging Feature

You can enable or disable the Page feature for your extension. If your extension is assigned to more than one page zone, the Page on/off feature code enables or disables your extension for all pages zone (you cannot select individual zones).

**To enable or disable paging for your phone:**

Dial **325** to enable paging. PAGE RECEIVE ON appears. Dial **325** again to disable paging.



# Hunt Groups

Hunt groups are groups of internal parties (agents) who share a common (hunt group) extension number. Calls can either be placed to the hunt group (using the hunt group extension number) or to a specific agent (using the agent's extension number). Hunt groups are programmed by the system administrator.

Hunt groups types are either "UCD" or "ACD."

- **UCD Hunt Groups:** Uniform Call Distribution (UCD) agents do not log in to the hunt group to receive calls.
- **ACD Hunt Groups:** Automatic Call Distribution (ACD) agents log in to the ACD hunt group to receive calls. Calls are distributed by either Agent IDs or extensions:
  - *Agent IDs:* Each agent is assigned an Agent ID number for logging in to the hunt group (see the next section). Hunt group calls are distributed to logged-in agents according to their Agent ID number instead of their extension number. Agents can log in to any ACD hunt group phone.
  - *Extensions:* Hunt group members do not use Agent IDs, and calls are distributed to phones where the agents are logged in.

## Logging in to ACD Hunt Groups

You must log in to an ACD hunt group to receive hunt group calls. To stop calls, you either log out of the ACD hunt group or divert calls. See "Diverting Hunt Group Calls" on [page 51](#).

<b>NOTES</b>	<p>Only one agent can be logged in to a phone.</p> <p>If the ACD Agent ID Automatic Connect option is enabled for your hunt group and you are using a headset, you are automatically connected to waiting calls when you log in. The first call you receive after you log in rings until you answer it; however, you are automatically connected to subsequent calls.</p>
--------------	---

**To log in to or out of all ACD hunt groups in which you are a member:**

Dial **328** to log in to ACD hunt groups followed by your Agent ID, if necessary. AGENT LOGGED INTO ALL ACDS appears. Dial **328** again to log out of all ACD hunt groups.

**To log in to one or more ACD hunt groups:**

1. Dial **326**. The display shows AGENT LOGIN ACD HG #.
2. Do one of the following:
  - Enter the ACD hunt group number.
  - Press **#** to log in to all of your ACD hunt groups.

The display shows AGENT LOGIN AGENT ID.

3. Enter your Agent ID (if applicable), or press **#** if you do not have an agent ID. The display shows the log in status for one or all hunt groups.

### Logging out of ACD Hunt Groups

You can log out of all ACD hunt groups at once or log out of each hunt group one at a time.

**To log out of one or more ACD hunt group:**

1. Do one of the following:

- Dial **328** to log out of all of your ACD hunt groups. The display shows AGENT LOGGED OUT OF ALL ACDS.
- Dial **327** to log out of one hunt group at a time.

*If you were logged in to only one hunt group, the display shows AGENT LOGGED OUT OF HUNT GROUP <number>.*

*If you were logged in to more than one hunt group, the display shows AGENT LOGOUT HG #. Enter the extension number of the ACD hunt group.*

### Stopping the ACD Hunt Group Wrap-up Timer

Each time you end an ACD hunt group call, a wrap-up timer starts. The default wrap-up time is 15 seconds. Your system administrator can change the wrap-up timer settings.

Until this timer expires, you will not receive another hunt group call; however, you can stop the wrap-up timer to allow calls to your extension.

**To stop the wrap-up timer:**

With the handset on-hook, dial **329**. The display shows ACD WRAP-UP TERMINATED.

### Other Hunt Group Features

The following features can be used by ACD or UCD hunt groups.

#### Requesting Agent Help

You can use Agent Help to request help from a designated “Agent Help Extension” (usually your supervisor) during a call. When your request call rings at the Agent Help Extension, the supervisor can join the call or reject the request.

---

**NOTE**

Agent Help is not supported on peer-to-peer (P2P) calls. Contact your system administrator for more information.



**To use Agent Help:**

1. While you are on a hunt group call, press **ⓧ** (Special), and then dial **375**.

If you hear repeating tones, one of the following has occurred:

- The feature is not available at your phone.
- You already have four parties in your call.
- Not enough system circuits are currently available.
- The Agent Help Extension is in DND.

**NOTE**

If you hear repeating tones, one of the following has occurred:

- The feature is not available at your phone.
- You already have four parties in your call.
- Not enough system circuits are currently available.
- The Agent Help Extension is in DND.

2. If not preprogrammed, dial the Agent Help extension number.

*If the Agent Help Extension accepts the call, AGENT HELP IN PROGRESS appears.*

*If the Agent Help Extension rejects the call, AGENT HELP REJECTED appears.*

## Diverting Hunt Group Calls

You can temporarily divert hunt group calls, preventing hunt group calls to your extension.

**To divert hunt group calls:**

Dial **324** to divert calls. The display shows the feature state DIVERT HUNT GROUP CALLS. Dial **324** again to program your phone to accept calls.

## Hunt Group Supervisor Features

The following features can be used by hunt group supervisors only.

### Accepting or Rejecting Agent Help Calls

Supervisors can accept or reject Agent Help calls.

**To accept an Agent Help request:**

Answer as usual. Your microphone is automatically muted.

**To reject an Agent Help request:**

Dial **376** or press the **REJECT HELP** menu button (5340 IP Phones only). AGENT HELP REJECTED appears.

### Monitoring Calls

You can use Station Monitor to connect to a hunt-group call and hear both parties, but you cannot be heard by either one. inter-station Monitor stops if the hunt group member terminates, transfers, or transfers the call. You can barge-in or “steal” monitored calls, as described in the following sections. You can also record the call. See “Using Record-A-Call” on [page 38](#) for more information about recording calls.

**To use Station Monitor:**

Dial **321** or press the **SIL MONITOR** menu button (5340 IP Phones only), and then enter the extension number. MONITORING EXT <number> appears. Monitored hunt group members may hear an “activation tone” when the feature is activated.

### Using Barge-in

While monitoring a hunt group call, you can use Barge-in to join the call.

**To barge-in to a hunt-group call:**

Dial **386** or press the **Barge-in** menu button (5340 IP Phones only). BARGE-IN PROGRESS appears.

### Stealing Hunt Group Calls

While monitoring a hunt group call, you can “steal” the call from the hunt group member, which disconnects the call from the agent and transfers the call to your extension.

**To steal a hunt group call:**

Dial **387** or press the **STEAL** menu button (5340 IP Phones only). CALL STOLEN FROM EXT <number> appears.

# Cordless Devices (5330/5340 IP Phones Only)

**NOTE** The 5320 IP Phone does not support a cordless module or cordless devices.

You can use the cordless handset and cordless headset to move around within your office or adjacent offices. The cordless headset and handset are optional accessories, ordered separately. For more information, contact your system administrator or local Mitel provider. Both cordless devices connect to your phone through the cordless module, which attaches to the back of the phone. The cordless headset rests and recharges in a headset cradle that attaches to the side of the phone. The cordless handset recharges in the handset cradle.

The Cordless Devices Application provides access to the configuration settings and information screens that apply to the cordless module and accessories. For more information, see “Pairing the Cordless Module and Devices” on [page 55](#).

The cordless module is shown here. The phone features are explained below.



Feature	Function
1 – Cordless Module	Attached to the back of the phone, the module contains a light-emitting diode (LED) indicating that a cordless device is in use; also indicates the pairing of module and a cordless device.
2 – Cordless Headset	Cordless handsfree operation for calls. If you are using the cordless headset, you do not need to use the handset.
3 – Cordless Headset Charging Cradle	Provides power to recharge the cordless headset battery.
4 – Cordless Handset Charging Cover	Provides power to recharge the cordless handset battery. Replaces the cover supplied with the phone for corded handsets.
5 – Cordless Handset	Cordless operation for handset calls. (You can transfer from the phone handset to the cordless headset at any time.)

## Cordless Module

The cordless module is shown here.

### ⚠ CAUTION

**Phone Damage Hazard.** Attempting to remove the back plate on the phone to install the cordless module before disconnecting the phone power supply may damage the phone. For information about installing the cordless module, refer to the installation documentation that is shipped with the unit.



Feature	Function
1 – Cordless Module pairing button	Initiates pairing between the cordless module and a cordless device.
2 – Cordless Headset Cradle cable	Connects to the cordless module to provide power to the charging cradle.

## Handset and Headset Combinations

The following combinations of corded and cordless headset and handset are supported on the 5330/5340 IP Phone:

- Corded handset only
- Corded headset only
- Corded handset and corded headset
- Cordless handset only
- Cordless headset only
- Cordless handset and cordless headset
- Corded handset and cordless headset
- Corded headset and cordless handset

## Pairing the Cordless Module and Devices

Before using the cordless handset or headset, each device must establish communication with the cordless module using a procedure called pairing.

### NOTES

- An IP phone can have only one cordless handset and one cordless headset.
- A cordless handset or headset can be paired with only one IP phone at a time.
- Pairing a new cordless handset or headset with the IP phone overwrites the configuration of any previous handset or headset.
- Pairing cannot be performed when the cordless device is already in use.

#### To pair a cordless device:

1. Ensure that the battery of the cordless device to be paired is at least partially charged.
2. Press and hold down the pairing button on the back of the cordless module (see [page 54](#)) for five seconds to activate phone pairing mode. The LED on the cordless module blinks. The Cordless Devices application opens on the phone and prompts you to press the pairing button on the cordless device.
3. Press and hold down the hookswitch on the cordless handset or headset for five seconds to activate the device pairing mode. The LED on the cordless device blinks. After a moment, the Cordless Devices application displays information for the device to be paired.
4. Press **Yes** to confirm pairing. The Cordless Devices application confirms the pairing by displaying the paired device name and its battery level indicator and the number of devices paired.
5. Press **Close** to exit.

#### To unpair a cordless device:

1. Press the blue  **Applications** key, and then press **Cordless Devs**.
2. Press the device name you want to unpair. The information screen for the selected device appears.
3. Press **Unpair this Device**. If the device is in use, an error message appears. Otherwise, the device is unpaired, removed from the display, and can no longer be used to interact with the phone.
4. Press **Close**.

The cordless module has a blue LED that indicates the current status of the module. The handset is blinking, when the LED is on and off for an equal amount of time.

Blue LED	Function
Solid	Audio is active between the module and either the handset or headset.
Blinking	Pairing mode is active or a firmware upgrade is in progress.
Off	No audio is active.
Solid for two seconds	Pairing is successful.

## Using a Cordless Device as a Remote Control

When not being used to talk, the cordless handset/headset buttons can act as a remote control device to change display contrast, volume, and mute settings on the host IP phone. For example, in a remote handsfree conference setting, you can use the Volume and Mute buttons on a cordless device to adjust speaker levels and mute the microphone on an IP phone that is not within his reach.

## Alerting Tones and LEDs

The cordless devices provide the following alerting tones:

Feature	Function
Mute key on cordless device ON/OFF	Two-pitch tone occurs immediately. Reminder tone occurs 30 seconds after activation and then regularly until deactivated
Mute key on phone ON/OFF	No immediate tone. Reminder tone occurs 30 seconds after activation and then regularly until deactivated.
Low battery (within 10 minutes left)	Three beeps and 20 second pause repeated three times.
Low battery (within 2 minutes left)	Three rapid beeps and 1.5 second pause repeated three times.
Out of range	Repetitive 3-pitch tone until you are back in range.

### NOTES

Audio indications are heard in the handset only when it is in use, and may interrupt voice transmission.

If you are out of range for more than 10 seconds, any call that is in progress is dropped and not recovered.

## Low Battery Level

When the battery of a cordless device reaches a near-critical level, the phone displays a warning. Until the battery is recharged (or until it becomes fully discharged), the warning is repeated at each new call. To continue with a call while charging the cordless device, switch to speakerphone and then cradle the cordless device.

## Cordless Handset

The cordless handset, shown below provides office mobility, allowing you to place and answer calls while away from your desk. Replacing the standard corded handset, the cordless handset contains a chargeable battery that charges in the handset cradle when not in use. To use the cordless handset, you must pair the handset with the phone. For more information, see “Pairing the Cordless Module and Accessories” on “Pairing the Cordless Module and Devices” on [page 55](#).



## Cordless Handset Features

Cordless handset elements are shown in the following table.

Feature	Function
1 – Cordless Handset LED	Blue: LED indicating the status of the handset. Green: LED indicating the status of the handset battery. For more information see <a href="#">page 58</a> .
2 – Hookswitch and pairing button	Lifting the handset from the cradle activates the handset. If the handset is already out of the cradle, pressing the hookswitch takes the handset off-hook. Pressing the hookswitch again returns it to on-hook. Pressing the hookswitch while on a speakerphone all, moves the call to the cordless handset.
3 – Mute button	Mute allows you to turn the microphone off during a call.
4 – Volume Up and Down button	Up and Down buttons provide volume control for the ringer and handset/headset.

## Answering Calls

### To answer a call:

Do one of the following:

- Lift the cordless handset.
- If the handset is already out of the cradle, press the hookswitch button on the handset.

## Hanging Up

### To hang up:

Do one of the following:

- Replace the cordless handset in the cradle.
- Press the hookswitch button on the handset.

## Cordless Handset LEDs

The handset has two LEDs:

- Blue – indicates the operational status of the handset.
- Green – indicates the status of the electrical charge of the battery.

The handset is blinking, when the LED is on and off for an equal amount of time. The handset is winking, when the LED is on for a short period of time and off for a longer period of time.

Led Color	LED State	Indicates
Blue	Solid	Handset is muted.
	Blinking	Handset is in pairing mode.
	Winking	Active audio path between handset and module.
	Off	No audio path between handset and module. Battery is dead.
Green	Solid	Battery is fully charged.
	Blinking	Battery is charging.
	Off	When handset is cradled and the LED does not flash or illuminate, this indicates an absence of battery power. During the first 30 – 60 minutes that the light is off, the battery may be trickle charging. If that is the case, the LED resumes normal behavior within that 60-minute period. If the LED remains off for more than 60 minutes, then either the battery is no longer chargeable or there is a problem in the charging circuit.

### NOTE

It is normal for the handset LED to cycle between blinking and solid as battery charge is maintained.



## Cordless Headset

The cordless headset offers the same capability as the cordless handset to make and answer phone calls away from your desk, while adding the convenience of hands-free operation.

When not in use, the cordless headset sits in the headset charging cradle. For more information on alerting tones and LEDs, see “Alerting Tones and LEDs” on [page 56](#).

To use the cordless headset, you must pair the headset with the phone. For more information, see “Pairing the Cordless Module and Devices” on [page 55](#).

### Cordless Headset Features

The cordless headset is shown here.

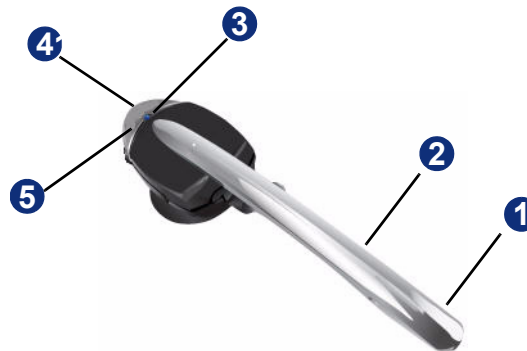

- |                            |                                   |
|----------------------------|-----------------------------------|
| 1 – Microphone             | 4 – Volume control                |
| 2 – Boom arm               | 5 – Hookswitch and pairing button |
| 3 – Linked Indicator (LED) |                                   |

### Answering Calls

**To answer a call:**

Do one of the following:

- Lift the cordless headset from the cradle.
- If the headset is already out of the cradle, press the hookswitch button on the headset.

### Hanging Up

If you are out of range for more than 10 seconds, any call that is in progress is dropped and not recovered.

**To hang up:**

Do one of the following:

- Replace the cordless headset in the cradle.
- If the headset is already out of the cradle, press the hookswitch button on the headset.

## Cordless Headset LEDs

There are two LEDs associated with the cordless headset:

- Blue – Indicates the operational status of the headset
- Green – Indicates the status of the electrical charge of the battery

The handset is blinking, when the LED is on and off for an equal amount of time. The handset is winking, when the LED is on for a short period of time and off for a longer period of time.

Led Color	LED State	Indicates
Blue (on headset)	Solid	Headset microphone is muted.
	Blinking	Headset is in pairing mode.
	Winking	Active audio path between Headset and Module.
	Solid for 2 seconds	Indicates one of the following: <ul style="list-style-type: none"> <li>• Pairing successful</li> <li>• New battery installed</li> </ul>
Green (on cradle)	Solid	Battery is fully charged.
	Blinking	Battery is charging.
	Winking	Indicates low voltage when headset is uncradled.
	Off	When headset is cradled, indicates battery is not charging.

## Using the Cordless Devices Application

The Cordless Devices Application provides access to module information and pairing for handor headsets.

**To access the Cordless Devices Application, do one of the following:**

- Press the blue Applications key and then press Cordless Devices
- Press a feature key you have programmed as the Cordless Devices Application key.

For information about programming feature keys, see [page 19](#).

<b>NOTE</b>	When the pairing button on the Cordless Module is pressed, or when the battery level of a cordless accessory is critically low, the phone will automatically open the Cordless Devices Application.
-------------	---

### Viewing Cordless Module Information

You can use the Cordless Module Application to view protocol, firmware, and hardware information about the module.

To view cordless module information:

- Access the Cordless Module Application.
- Press Cordless Module Info. Device information appears on the screen.
- Press Close to exit.

# Troubleshooting

The following sections can help you solve problems that you may be experiencing with your phone. Troubleshooting topics include:

- **Contact Information:** Information about system administrator contacts.
- **Error Messages:** Error messages and descriptions.
- **Troubleshooting Tips:** Possible problems and methods to solve them.

## Contact Information

Your system administrator can help you with items such as changing your settings or modifying phone features. System administrator duties include:

- Adding new user accounts.
- Setting the date and time.
- Programming System Speed-Dial numbers.
- Making database changes, such as changing user names and extension numbers.

Contact your system administrator with questions that are not covered in this user guide. If you need further assistance, you can find provider information on the [Mitel Web site](http://www.mitel.com) (www.mitel.com). All sales, service, and support are coordinated at the local level.

## Error Messages

The following error messages may appear when using your phone.

Message	Reason
CANNOT ACCESS FEATURE	The feature is enabled but other feature-related conditions were not met. Make sure that all feature-related conditions are met and retry.
CANNOT ACCESS RESERVED FEATURE	Your system does not support the feature. Contact your system administrator for more information.
INVALID FEATURE CODE	The feature code entered does not exist. Retry using the correct feature code (see <a href="#">page 16</a> ).
INVALID EXTENSION NUMBER	The extension number entered does not exist. Retry using a valid extension number.
NO UPDATE PERFORMED	The feature was not completed or one or more feature conditions were not met.

## Troubleshooting Tips

The following table includes troubleshooting tips for phone and system features.

**NOTE** You can often correct problems that you may be experiencing by resetting the phone to the default settings. See “Resetting the Phone to the Default Settings” on [page 19](#).

Problem	Possible Solution
The phone is not working properly.	Contact your system administrator.
I cannot use one or more of the features described in this guide.	The feature may not be enabled. Contact your system administrator for more information.
I cannot program System Speed-Dial numbers.	Your system administrator programs System Speed Dial numbers.
I cannot change the time and date on the phone display.	Your system administrator programs the time and date. Contact your system administrator if you notice that the date and time are incorrect.
I am experiencing audio problems on my phone such as echo, distorted sound, or choppiness.	Contact your system administrator if you are having audio problems.
The name on the display is incorrect.	Your system administrator assigns display names.
I cannot use the local telephone company star codes (for example, *82, *69) when I press the <b>Outgoing</b> button or use the Outgoing Call access code ( <b>8</b> is the default code) when calling an external number.	Rather than pressing the <b>Outgoing</b> button or <b>8</b> to access an outside line, you must dial a Select Line Group number before you can use the star codes. For example, if your system is using the default Select Line Group numbers, dial 92001 to access that line. After you have dial tone, you can dial the star code and the number.
I cannot use the Agent Help or Record-a-Call features.	If your system uses Peer-to-Peer (P2P) audio, you cannot use these features when you are on a P2P call. Contact your system administrator for more information.
I cannot program a inter-station Speed-Dial number to the button I want.	Before assigning the speed-dial number to a programmable button, you must store the number with either a inter-station or System Speed-Dial code.

Problem	Possible Solution
<p>When I try to use the Personal Call Routing – Handoff feature (<b>388</b>), the display shows NO CALL TO HANDOFF.</p>	<p>The NO CALL TO HANDOFF display indicates that the call cannot be handed off because one of the following may have occurred:</p> <ul style="list-style-type: none"> <li>• You tried to use the Handoff feature on a call that has not been routed by Personal Call Routing.</li> <li>• You tried to use the Handoff feature on a call that the system has not yet recognized as a valid call.</li> <li>• You tried to use the Handoff feature on an unsupported extension. The Handoff feature is supported on your main extension only.</li> <li>• You tried to use the Handoff feature on a phantom extension. The Handoff feature is not supported on phantom extensions.</li> <li>• You entered the handoff feature code at the exact time the other party on the call disconnected.</li> <li>• The call was terminated for some reason.</li> </ul>



# Index

## Symbols

- 5320/5330 IP Phone Features 2
- 5340 IP Phone Features 3

## A

- About Your Phone 1
- Account Codes, using 29
- ACD Hunt Group Wrap-up Timer, stopping 50
- ACD Hunt Groups
  - logging in 49
  - logging out 50
- Agent Help
  - accepting or rejecting 51
  - requesting 50
- Agent Help Calls, accepting or rejecting 51
- Agent Help, requesting 50
- Agent, ACD hunt group 49
- Alerting Tones and LEDs 56
- Angle, adjusting and viewing 9
- Audio Problems 62
- Automatic Access, using 21
- Automatic Call Access, using 21
- Automatic Trunk Answer, using 22

## B

- Background Music 15
- Barge-In, using 52
- Button Assignments, viewing 19
- Buttons 5

## C

- Call Forward
  - Manual 34
  - System 34
  - using 34
- Call Logging, using 39
- Call Logs, using 39
- Callback (Queuing the Phone), requesting 23
- Caller ID Information
  - displaying 33
  - viewing 33

## Calls

- answering 21, 58, 59
- camping-on to phone 23
- conference 37
- conference, placing 37
- emergency, placing 22
- external 24
- external, placing 24
- forwarding 34
- logs, using 39
- monitoring 52
- muting the microphone 31
- phone, queuing for 23
- picking up (reverse transferring) 33
- placing 22
- placing internal (IC) 23
- recording 38
- redirecting 22
- stealing 52
- transferring 32
- waiting 21
- Calls On Hold, placing 32
- Calls to External Numbers, transferring 33
- Calls to Other Extensions, transferring 32
- Camp-On, using 23
- Characters, entering dialpad 25
- Codes
  - account 29
  - default system access 16
  - feature, default 16
  - Outgoing Call access 22, 24
- Comfort and Safety Tips 7
- Conference and Placing all Parties on Hold, ending 38
- Conference Calls
  - adding a party to 37
  - dropping out of 37
  - ending 38
  - placing 37
  - transferring 37
- Conference Party, adding 37
- Contact Information 61
- Cordless Device as a Remote Control, using 56
- Cordless Devices
  - alerting Tones and LEDs 56
  - application, using 60
  - cordless handset 57
  - cordless headset 59
  - cordless module 53
- Cordless Devices Application, using 60

## Index

---

Cordless Handset 57  
    features 57  
    LEDs 58  
Cordless Headset 59  
    features 59  
    LEDs 60  
Cordless Module 54  
Cordless Module and Devices, pairing 55  
Cordless Module Information, viewing 60  
Cordless Modules and Devices, pairing 55

## D

---

Default  
    access codes 16  
    feature codes 16  
    programmable buttons, resetting to 19  
    settings, returning the phone to 19  
    system access codes 16  
Dialpad  
    buttons 5  
    characters, entering 25  
Dialpad Buttons to Enter Characters, using 25  
Direct Station Selection/Busy Lamp Field (DSS/BLF) unit 15  
Directory, using 28  
Display 4  
Display Contrast and Brightness, adjusting 10  
Display Name, changing 62  
Diverting Hunt Group Calls 51  
Do-Not-Disturb (DND), using 45

## E

---

Emergency Calls, placing 22  
Error  
    messages 61  
    tones, phone 7  
Error Messages 61  
Extension Numbers 16  
External Calls, placing 24  
External Numbers, redialing 24

## F

---

Feature  
    buttons 5  
    canceling 5  
    codes, using 16  
Features to Programmable Buttons, assigning 15

## G

---

Group Listen, using 38

## H

---

Handset 3  
    off-hook 7  
    off-hook, on-hook 7  
    on-hook 7  
Handset and Headset Combinations 54  
Handsfree Mode  
    overriding 31  
    using 31  
Hang Up 58, 59  
Headset Instructions 8  
Headset, using 8  
Hold  
    Individual 32  
    System 32  
Hookflash, entering 32  
Hunt Group Calls  
    diverting 51  
    stealing 52  
Hunt Group Calls, stealing 52  
Hunt Group Supervisor Features 51  
Hunt Groups  
    accepting or rejecting Agent Help 51  
    Agent Help, requesting 50  
    agent IDs 49  
    Automatic Call Distribution (ACD) 49  
    Barge-In, using 52  
    calls  
        diverting 51  
        monitoring 52  
        stealing 52  
    logging out of 50  
    types 49  
    Uniform Call Distribution (UCD) 49  
    wrap-up timer 50

## I

---

Individual Hold, using 32  
Internal Calls, placing 23



## K

---

- Keymaps
  - changing 19
  - switching 19

## L

---

- Language, changing 14
- Logs, call 39
- Low Battery Level 56

## M

---

- Manual Call Forwarding 34
- Members, hunt group 49
- Menu Buttons (5340 IP Phones only) 6
- Messages
  - canceling 44
  - deleting 44
  - Do-Not-Disturb 45
  - error 61
  - leaving 43
  - pages 47
  - Reminder 46
  - replying to 44
  - viewing 44
  - viewing and responding 44
  - voice, listening to 44
- Messages at Other Extensions, leaving 43
- Messages Left at Other Extensions, canceling 44
- Microphone, muting 31
- Music, background 15
- Mute, using 31

## N

---

- Navigation Page Buttons 6
- Number, redialing 24
- Numbers, redialing external 24

## O

---

- Off-Hook 7
- On-Hook 7
- Other Hunt Group Features 50
- Outgoing Call Access Code 22, 24
- Outside Line Access Codes 16

## P

---

- Page Announcement, placing 47
  - Paging
    - enabling or disabling 47
    - other system users 47
    - using 47
  - Paging Feature, enabling or disabling 47
  - Password, Remote Programming
    - changing 41
    - entering 40
  - Personal Call Routing
    - enabling and disabling 36
    - handoff 36
  - Phone
    - 5320 IP Phone 2
    - 5330 IP Phone 2
    - 5340 IP Phone 3
    - blank display 1
    - changing volume levels 10
    - comfort and safety 7
    - default settings, returning to 19
    - error tones 7
    - feature descriptions 3
    - features
      - dialpad buttons 5
      - feature buttons 5
      - menu buttons (5340 IP Phone) 6
      - Navigation Page Buttons 6
      - Ring/Message Indicator 4
      - speaker 4
    - ring tone, selecting 10
    - signals 7
    - viewing angle, changing 9
  - Phone to the Default Settings, resetting 19
  - Programmable Buttons 6
    - resetting 19
    - resetting to default values 19
    - using 15
    - viewing button assignments 19
- ## R
- 
- Record-A-Call, using 38
  - Reminder Messages, using 46

## Index

---

Remote Programming 40

- change DND settings , using 41
- change the password, using 41
- forward calls, using 42
- password
  - changing 41
  - entering 40
- password, entering 40
- Personal Call Routing 42
- using 40

Reverse Transfer (Call Pickup), using 33

Ring Intercom Always, using 31

Ring Message Indicator 4

Ring Tone

- changing 10
- selecting 10

Ring/Message Indicator 4

## S

---

Screen Saver, using 11

Secondary Extension Buttons, using 40

Settings, returning to default 19

Signals, phone 7

Speaker 4

Speaker, external 4

Speakerphone

- description 4
- Group Listen, using 38
- handsfree calls 31

Speed Dial

- entries to programmable buttons, assigning 27
- entries, deleting 27
- station, using 25
- system, using 24
- using 24

STAR Codes, telephone company 62

Station Messages

- canceling 44
- deleting 44
- leaving 43
- replying to 44
- viewing 44

Station Monitor, using 52

Station Speed Dial

- numbers
  - deleting 27
  - dialing 26
  - storing 25
- using 25

System

- forwarding 34
- Hold 32
- information 8
- information, displaying 33
- time and date, setting 62

System Speed Dial, using 24

## T

---

Text Size on a Display, changing 14

Time and Date, system 62

Tips

- comfort and safety 7
- troubleshooting 62

Transferring Calls 32

Troubleshooting Tips 62

## V

---

Viewing Angle, adjusting 9

Voice Mail User Guides 43

Voice Messages

- deleting 44
- leaving 43
- listening to 44

Volume Levels 10

Volume Levels, changing 10

## W

---

Waiting Calls, answering 21

Waiting Inter-Station Messages, deleting 44

Welcome 1

Wrap-Up Timer, stopping 50

## Y

---

Your System Information, viewing 33



Part No. 550.8123  
Issue 3, September 2009

